

The Art of *Economy*

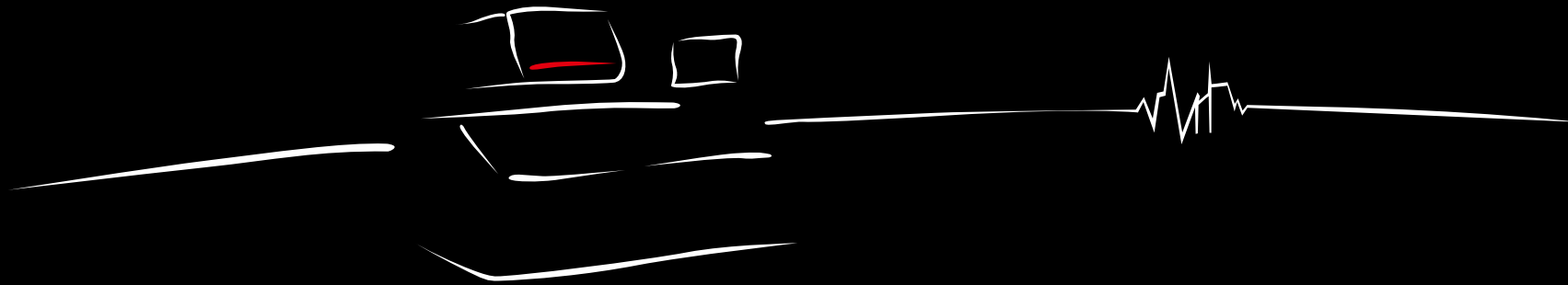



1964

1970

1980

1990

2000

2010

2025

## 42 model series since 1964.

An assurance of innovation and dependability.

Mitsubishi Electric . . . . .	5	Highlights . . . . .	7
<b>Functions and machine concept</b>			
Machine concept . . . . .	9	Dialogue-assisted navigation . . . . .	25
Design . . . . .	11	Professional mode . . . . .	27
Tubular Shaft Motor . . . . .	13	Intelligent user guidance . . . . .	29
Crash Protection System . . . . .	15	Job scheduler . . . . .	31
Wire threading . . . . .	17	Monitoring . . . . .	33
Generator technology . . . . .	19	New intelligence . . . . .	35
Precise Finish Circuit . . . . .	21	Remote control . . . . .	37
Corehold . . . . .	23		
<b>Profitability / Options / Services</b>			
Maintenance-friendliness . . . . .	39	Examples of applications . . . . .	51
Profitability . . . . .	41	Service . . . . .	53
Optional extras and non-standard materials . . . . .	45	Training . . . . .	55
Automation . . . . .	49		
<b>Specifications</b>			
Key data . . . . .	57	Technical data . . . . .	61

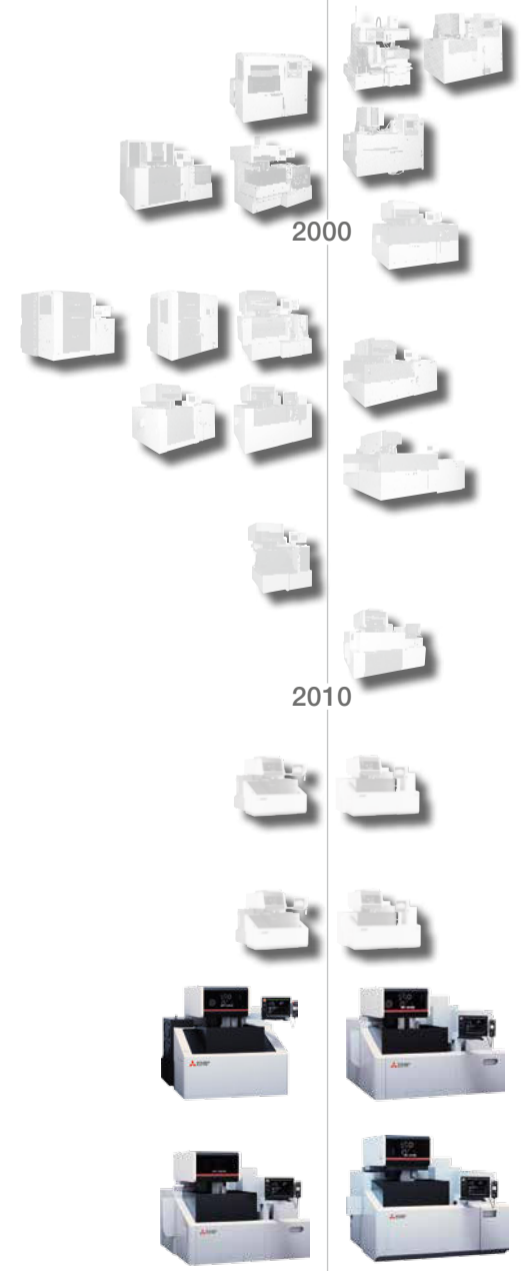





**If you've got grand designs,**  
you need someone strong you can count on.



Since 1970, a growing number of European companies have therefore been turning to high-performance EDM machines from world market leader Mitsubishi Electric.

Only by producing components in-house is it possible to tailor them perfectly to the intended task. Mitsubishi Electric resorts to its own controls, semiconductors, motors and other items, which are adapted in detail to all requirements. The only thing you notice is that it works – and often for many decades after purchase.

If you want to invest soundly in a durable EDM machine, choose **Mitsubishi Electric**.





**Intuitive operation – for the benefit of the machine operator.**

The user interface is child's play to handle – gesture control inclusive. While some choose dialogue-supported user guidance, others opt for professional mode to get off to a speedy start. The control adapts to the user.

Continued on page 27



**Extra precision and speed thanks to the generator that not only thinks, but also thinks ahead.**

If you want to achieve better surface quality with fewer recuts, you need the right blend of mutually adapted technologies. With Precise Finish Circuit, you achieve more precise results faster.

Continued on page 21



**An EDM system must help your company to make money.**

The MV-R Series cuts expenditure on electricity, wire and filters considerably – so that you can earn more. The machine is designed for decades and has extra-low maintenance needs thanks to intelligent technologies.

Continued on page 39



**Thrilling technology.**

**The machine results you expect – in a playful, transparent, efficient and reliable process**

These days, the operation of a CNC machine no longer has to be complicated – the dialogue guidance of the CNC helps less experienced machine operators to reliably accomplish their tasks. The transparency of the machining processes on the EDM system and overviews of the state of maintenance and resource consumption are a help with cost analysis and preventive maintenance. The analysis functions thus help to boost efficiency by exploiting capacities and resources better – and boost the proverbial reliability of the EDM systems from Mitsubishi Electric still further.

**The speed of light...**

...for communication by fibre optics. The Tubular Shaft Motor with its highly responsive control fully exploits the benefits of high communication speed. No heat, no maintenance and no contact – just extra precision for good. At Mitsubishi Electric, this is known as "Changes for the Better".

Continued on page 13



**Wire break point insertion even on thick and interrupted workpieces.**

The time-consuming return to the starting point is omitted – and machining continues where it left off, thanks to the highly advanced wire annealing system. Depending on machining conditions, threading can be successfully performed with or without jet stream and even submerged – depending on workpiece thickness.

Continued on page 17





MV2400R Connect – the perfect blend of performance and ergonomics



## Ergonomic machine strategy

enabling you to concentrate on the essential.

### Focus on ergonomics



Set-up, programming, maintenance etc. – all the key elements are directly accessible at the front of the machine. The entire wire feed, automatic wire threading and wire guide heads plus the whole workspace are readily accessible – not least thanks to the open design and automatic vertical sliding door.

### Intelligent D-CUBES control



... simply shifts the future into the present. The user has almost half a metre of user interface to work with, assisted in this by the mouse and the usual computer keyboard. The monitoring of the machining process generates neatly displayed information at a glance and detailed analysis where desired.

### Network for productivity

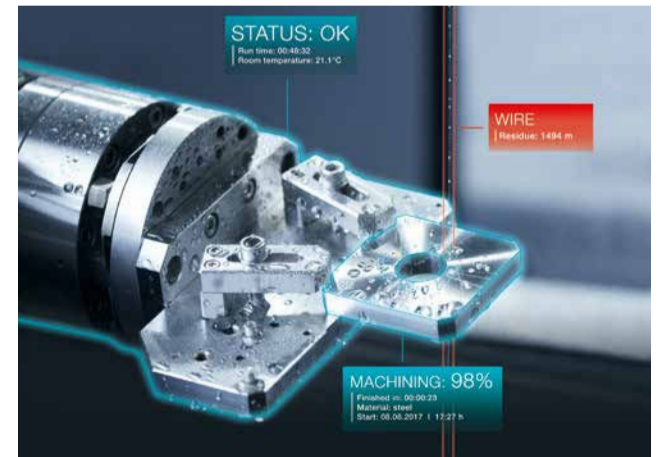

All the critical data can be conveniently retrieved through the ERP system. The Controller supplies all relevant operational data for further external use – as a standard function. Important interfaces such as Ethernet TCP/IP are of course part of the package.



### Ingenious drive positioning

If you want extra-smooth axis movements, you have to position the drives right in the centre of the moving weight – so that the superior Tubular Shaft Motor can exploit its full potential. Glass scales right next to the work space are an assurance of maximum precision right from the start.

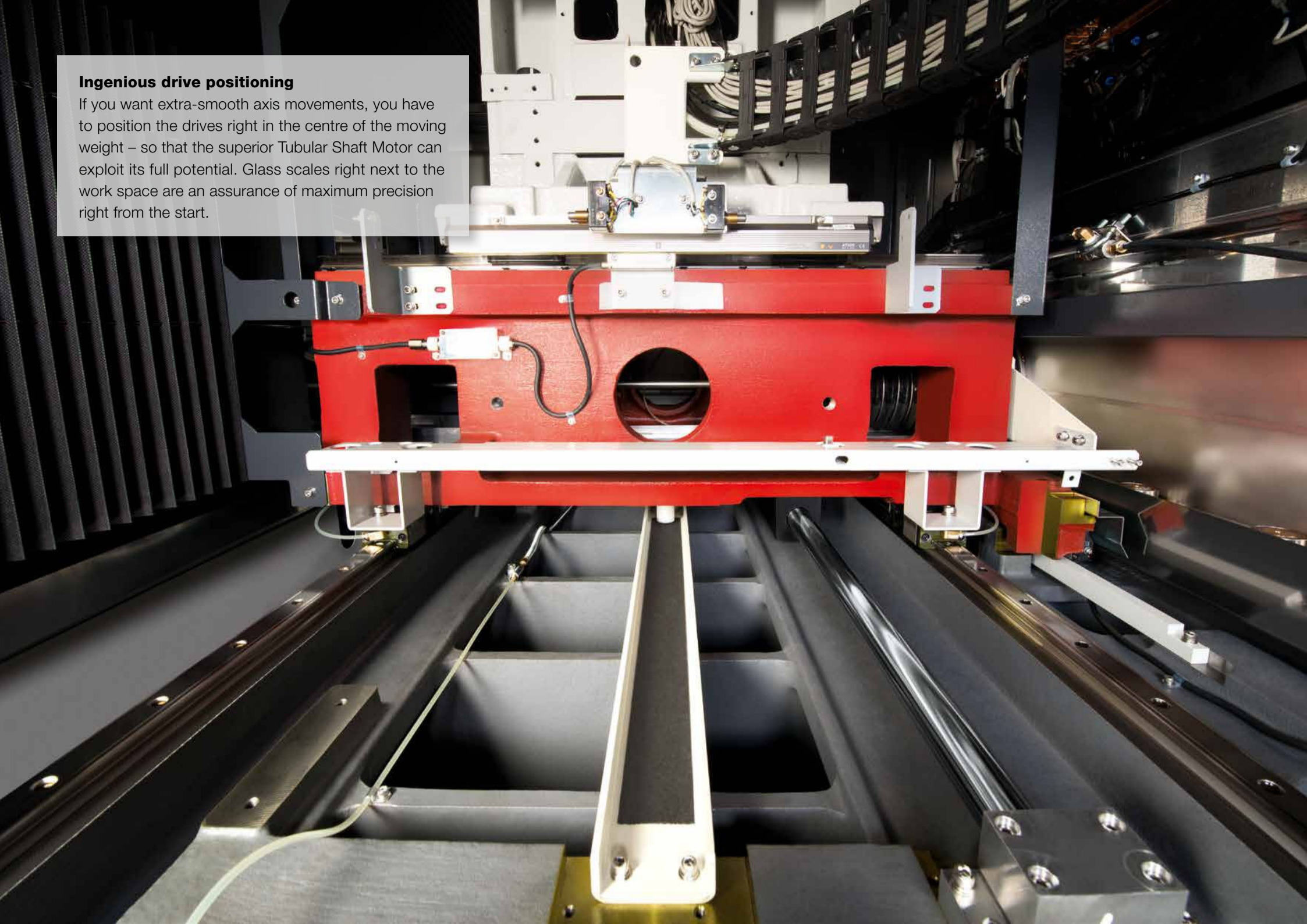

## Tons of solidity cast in steel.

### Solid machine body



The specially selected Meehanite casting ensures durability that can be measured in decades and copes with high workpiece weights day after day. The rugged machine bed takes even the severest punishment in its stride – unlike many a less expensive material.

### Durable hardened stainless steel table

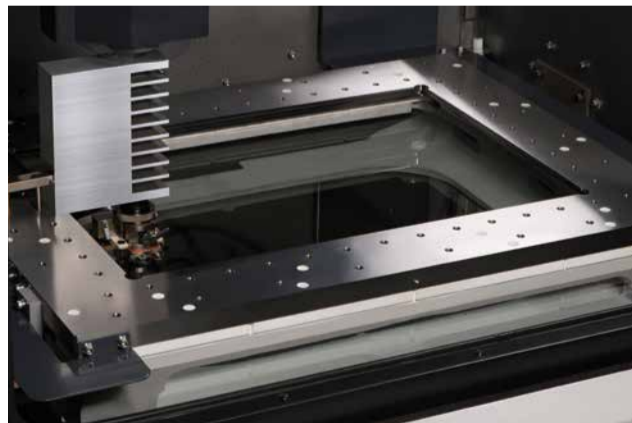

The four-sided table is insensitive to dielectric and sludge for decades. High-grade stainless steel components and the stainless steel work tank ensure dependability and maintenance-freedom.

### The door that simply vanishes...



...so that you have direct access. This saves time and space and makes workpiece set-up that much easier.



The Tubular Shaft Motor converts energy directly into motion, without contact, without maintenance and above all without loss of precision – long-term. Combined with the 400% faster fibre-optic-based control, this superior technology can truly show what it is capable of.

The positioning accuracy even of the large MV2400R is  $< \pm 2 \mu\text{m}$  over the entire travel path – there's a genuine 12-year manufacturer warranty for this on all Mitsubishi Electric EDM systems. An assurance of top-level durability.

Your company's technological edge has a name: Tubular Shaft Motor – from world market leader Mitsubishi Electric.



Find out more about it here:  
[www.mitsubishi-edm.de/tsm](http://www.mitsubishi-edm.de/tsm)

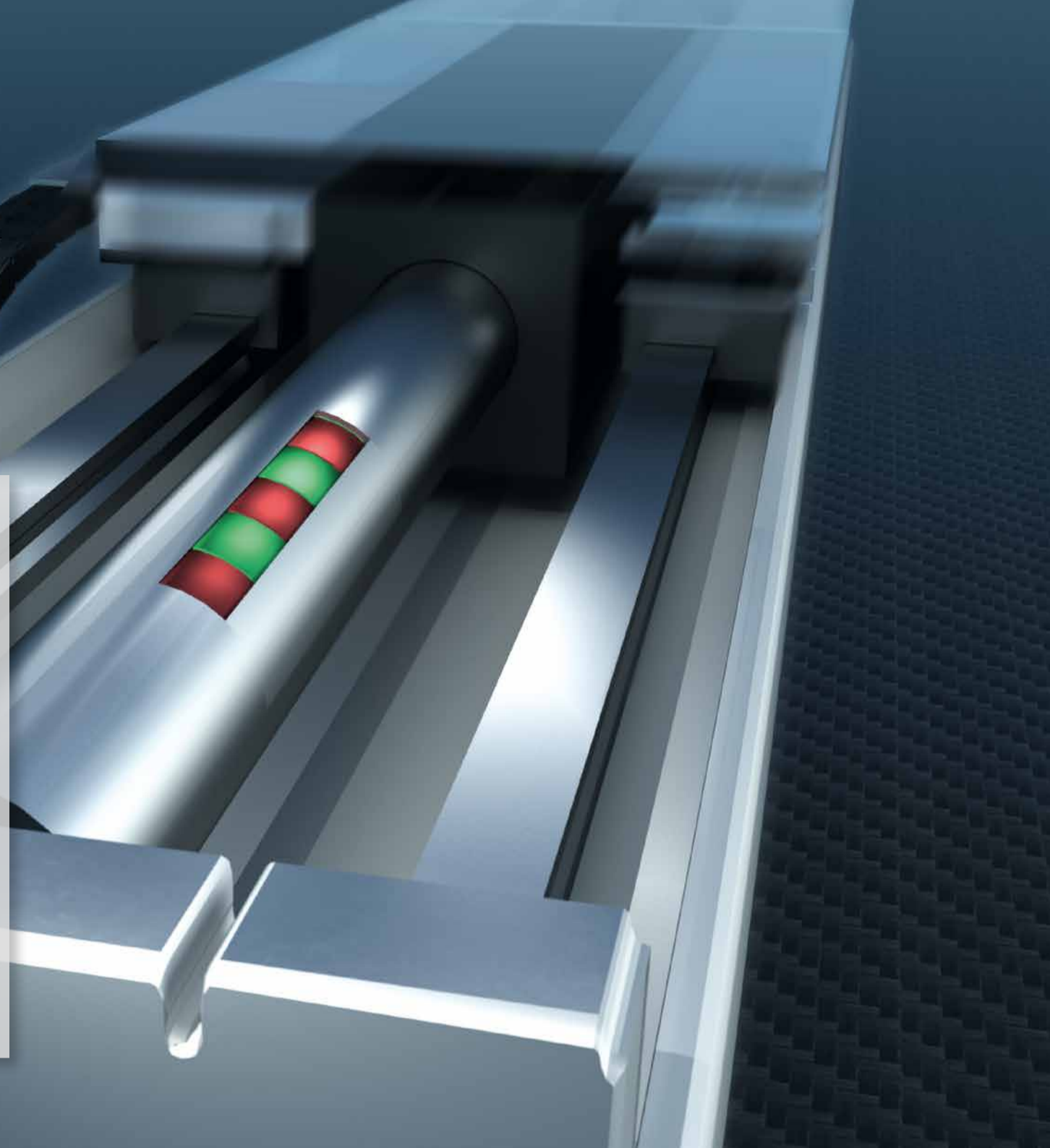

## 12-year warranty on positioning accuracy.



### Perfect drive



What was it about conventional drive systems that bothered developers at Mitsubishi Electric? The need for lubrication, the friction and frictional heat, power consumption, backlash, the cogging moment and above all the possible wear. Only a non-contact drive overcomes these drawbacks from the outset and is thus an assurance of better results and enhanced dependability over decades.

### Speed of light



The Mitsubishi Electric polymer optical fibres have decisive advantages – not only over conventional copper cables, but also over glass fibres. Not only their total resistance to water, but also their high transmission rates combined with minimal space requirements and maximum flexibility are essential for truly progressive EDM systems. The only thing that you as a user notice is the longer service life and enhanced precision.

### No disruptive cogging torque

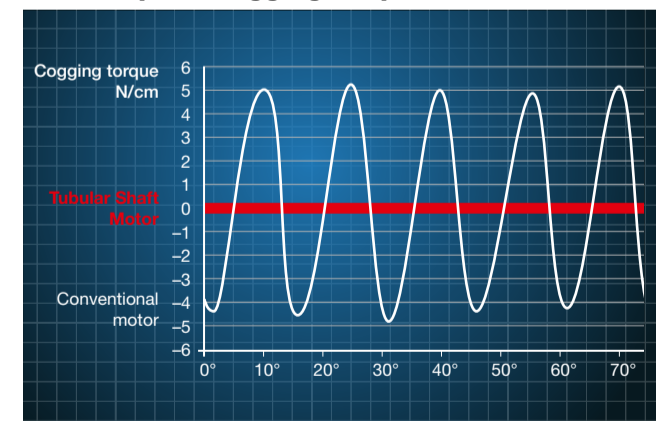

You're surely familiar with the cogging torque manifested by a conventional electric motor. It is precisely this cogging torque that is undesirable, as are variations in torque. The Tubular Shaft Motor – the optimal drive for precision applications like electrical discharge machining.



A considered and far-sighted approach is the best safety policy – but what if things have to be done in a rush? An intelligent EDM system that spots and prevents possible collisions contributes to safety at work and saves annoyance and time.

## Crash Protection System already installed.



### The in-built “guardian angel”

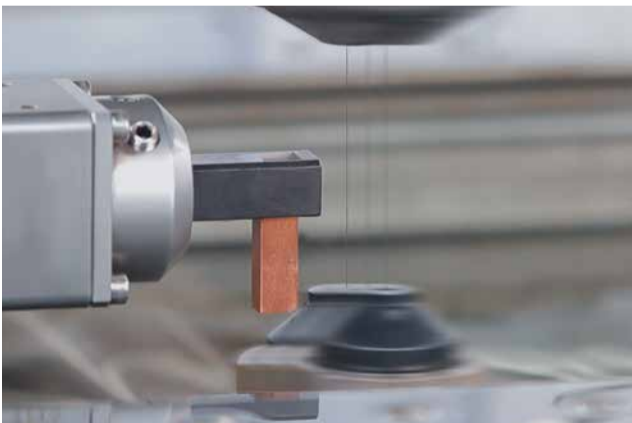

Care, attention and good planning are an assurance of immaculate results, even with the most advanced technology. And should the unexpected nevertheless occur, all the wire-cut EDMs from Mitsubishi Electric come with an in-built “crash protection system”.

### Fully automatic

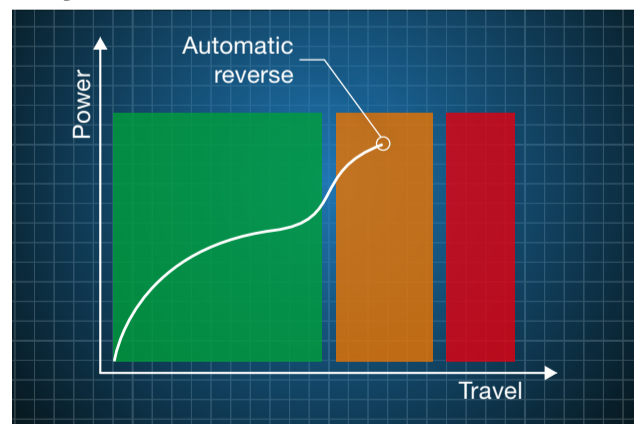

The wire-cut EDM systems from Mitsubishi Electric constantly check current axial forces and thus fully automatically detect potential accidents before they happen. If there is an obstacle in the travel path, this is electronically detected on the basis of the drive's load change during the approach and the control automatically reverses. Better safe than sorry!

### Crash Protection System in action



See for yourself and watch the dependable Crash Protection System from Mitsubishi Electric in action!



Straight to the film:  
[www.mitsubishi-edm.de/cps-en](http://www.mitsubishi-edm.de/cps-en)





## Threading even in the most difficult conditions



Watch film now:  
[www.mitsubishi-edm.de/threader](http://www.mitsubishi-edm.de/threader)

## Vastly superior.

The wire threader for maximum dependability.



### Wire break point insertion even on thick and interrupted workpieces



The time-consuming return to the starting point is omitted – and machining continues where it left off, thanks to the highly advanced wire anealing system. Depending on machining conditions, threading can be successfully performed with or without jet stream and even submerged – depending on workpiece thickness.

### Round diamond guide



Maximum precision and durability ensure the best results in the long run – inclusive of maintenance-friendliness due to a small number of parts and simple design.

### Flexibility – when it comes to wire diameter

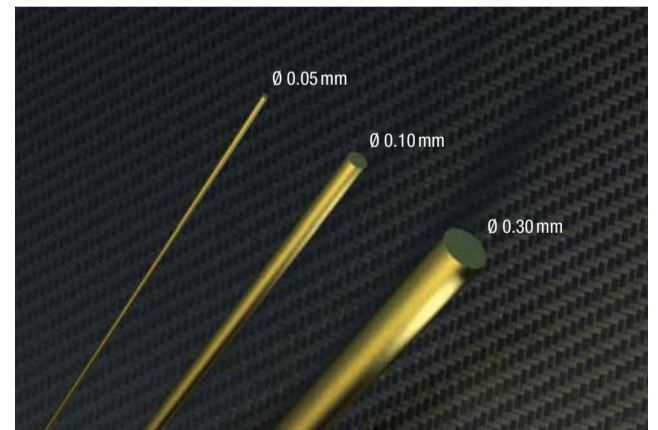

Intelligent AT is designed for wire thicknesses of 0.10–0.30 mm, i.e. the right range for more than 95% of all applications. But what if you need thinner wire? No problem. Intelligent AT is optionally available for the 0.05–0.30 mm range as well.





## Greater speed and accuracy – and you save more.



### Response time is decisive

An EDM machine that reacts with greater speed and precision achieves better surface quality faster. The new V350 generator has a significantly higher effective clock rate. The voltage is built up faster and with greater precision thanks to reduced capacitance loss. Thanks to faster voltage build-up, spark duration and working voltage can be lowered. All that you will probably notice is higher surface quality and lower power costs.

### 17% faster multi-pass jobs



4 cuts of Ra 0.28  $\mu\text{m}$  compared to a conventional machine.

### 0.12 $\mu\text{m}$ surface quality

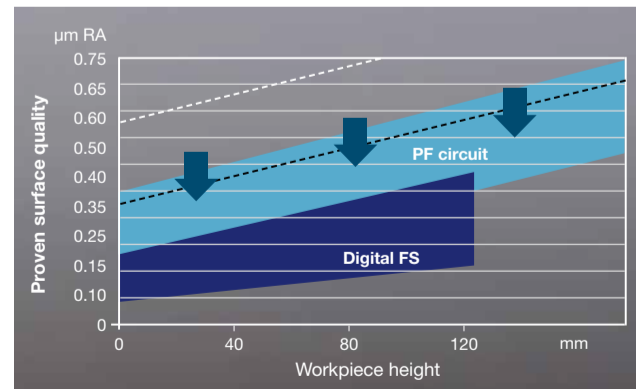

The proven digital fine finishing generator (D-FS) is also optionally available for the MV-R Series.

### New H-FS generator stage

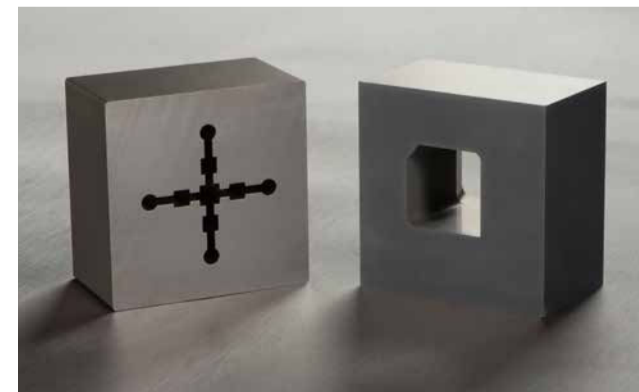

Achieve surface finishes as good as Ra 0.2  $\mu\text{m}$  in the standard version – by using the V350 generator with H-FS technology.



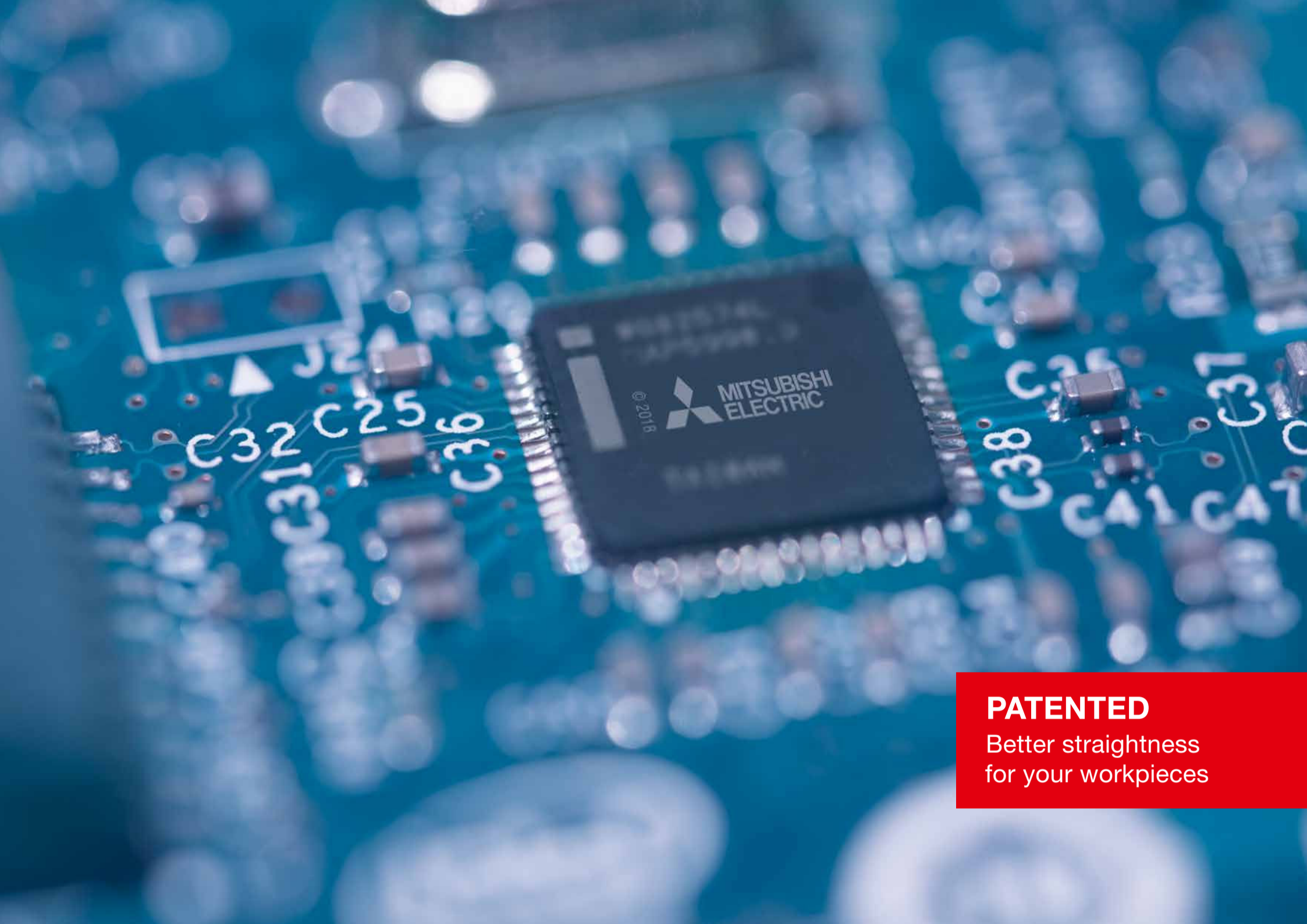

**PATENTED**  
Better straightness  
for your workpieces

## Precision for steps and around corners.



### Process Control at its best – Power Master

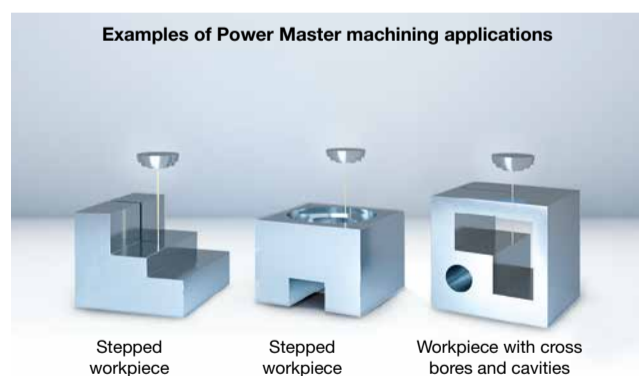

The Power Master Control gives the most highest level of process stability – whatever the shape being cut. Stepped workpiece shapes, boreholes and other obstacles to a stable cutting process are identified as soon as they appear and the control adopts cutting and flushing parameters for a safe process and superlative accuracy.

### Getting a grip on radii and corners

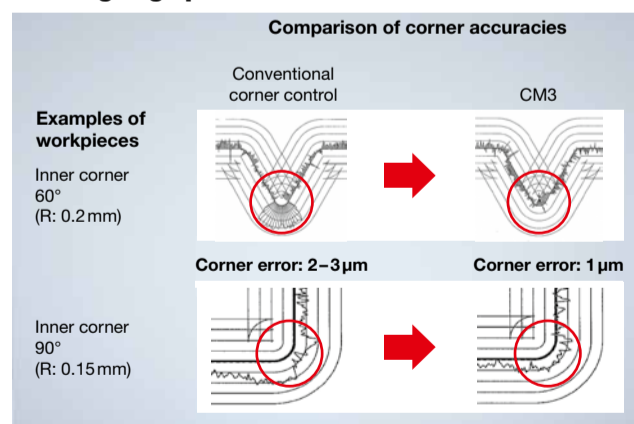

On small inner and outer corners and complicated geometries, Corner Master 3 comes to your aid. You merely define your priorities, and optimisation is performed accordingly.

### Better straightness and shape accuracy

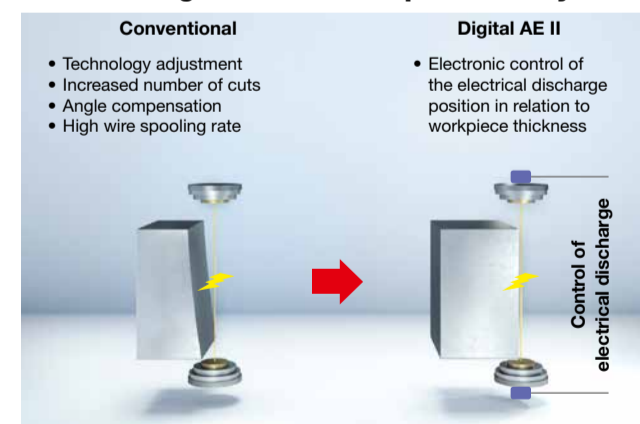

With precise control of the electrical discharge position, material is only removed where it needs to be. The patented functions of the Digital AE II improve rough and fine machining and fine finishing – in terms of both precision and machining time.



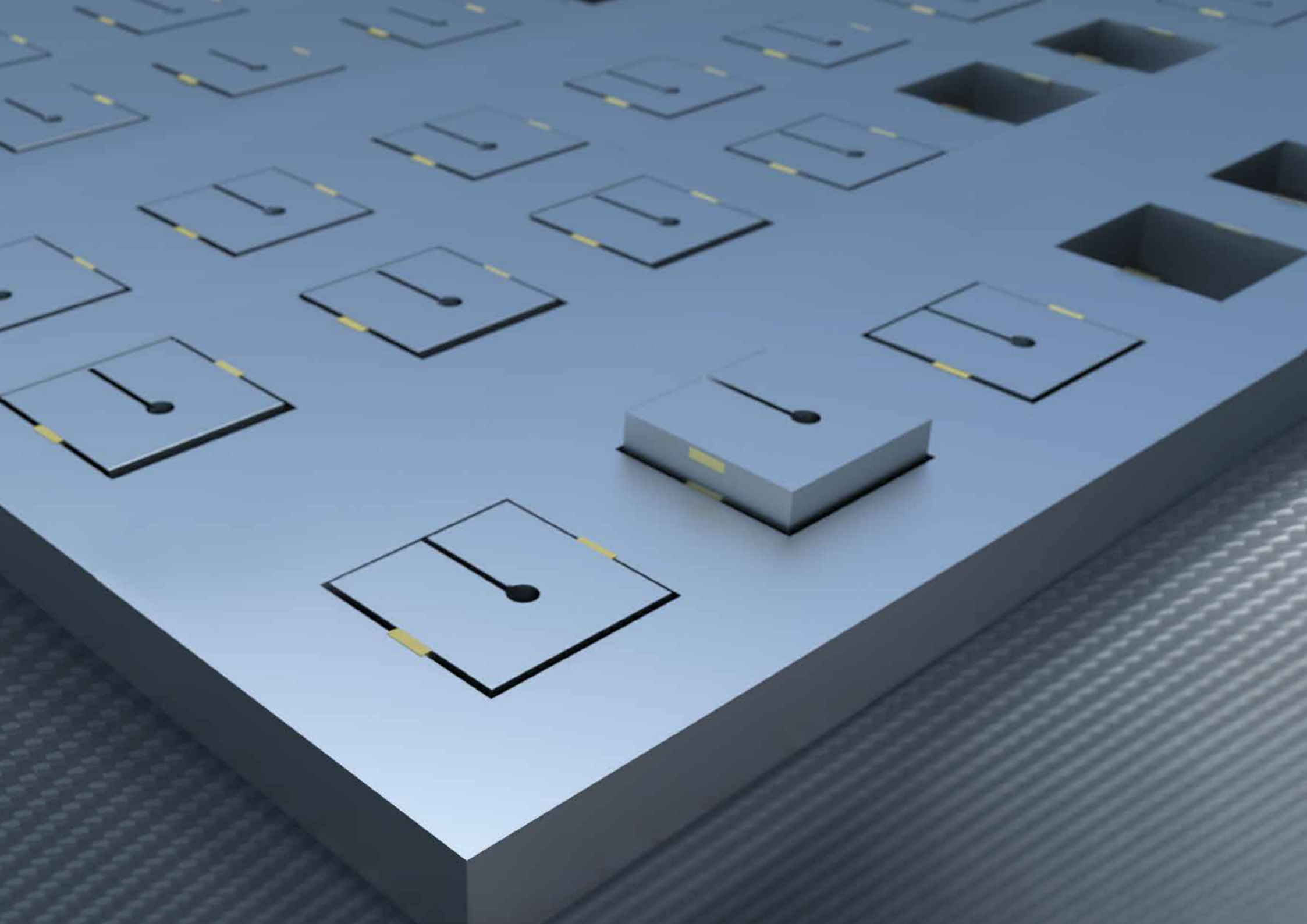

## Corehold.

Intercepting the waste – fully automatically.



### Intercepting the waste – fully automatically

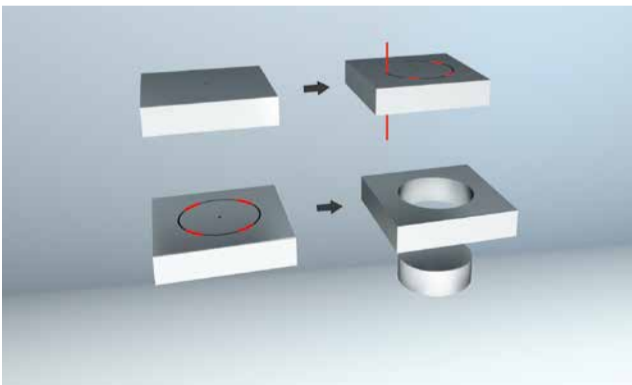

During roughing, a bridge is controllably created to hold the waste material – the waste material cannot fall. In this way many features can be rough-machined and, after removal of the waste material, recut – fully automatically and unmanned, overnight and at weekends. Lower costs, higher profits.

### Long-running jobs with multiple cut-outs

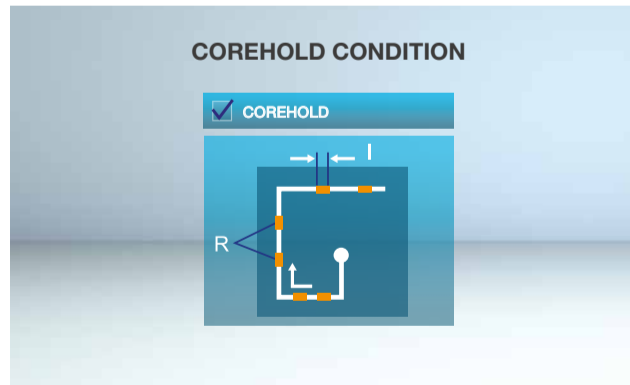

The number and length of fixing points are easy to set in different ways: directly via a comfortable dialogue menu within the CNC or on external programming systems supporting this function.

### Reducing machining time



Standard core connections are replaced by easily removable fixing points, thus reducing the manual time for picking up core parts dramatically. Instead of cutting off the material bridges slowly, the core can be easily removed from the workpiece with slight manual pressure to the core, so the finishing process can start sooner. Remarkable time saving in detail help to reduce overall processing time, contributing to higher process efficiency.





**A masterpiece of intelligence – a control that pitches in**

## Dialogue-assisted navigation.

The fast way to the perfect result.



### Slim ergonomic manual control box



The ergonomically designed, intelligent manual control box unites all the relevant functions for control and set-up in a single unit. The integrated LCD display can be individually configured by the operator. Inclusive of buttons for driving all 8 possible CNC axes.

### Multi-touch display with gesture control



Intuitive operation from the large screen with modern gesture control boosts comfort, while the configurable user interface supports the user by allowing the main functional elements to be freely arranged during daily work.

### An easy start thanks to dialogue guidance



With step-by-step dialogue guidance, less experienced users are piloted through the entire process, from programming through to the start of machining. Checklists make it possible to review all process-relevant settings and machine states so that machining yields the best possible results without interruption.





## Professional mode – tailored to your needs.



### Everything at a glance



The easy-to-grasp display of all the key machining parameters in configurable form keeps everything under control at all times. Clearly visible at a glance are – if desired – machining status, elapsed times, state of maintenance and other data. Configuration couldn't be simpler.

### Work scheduling – at the machine

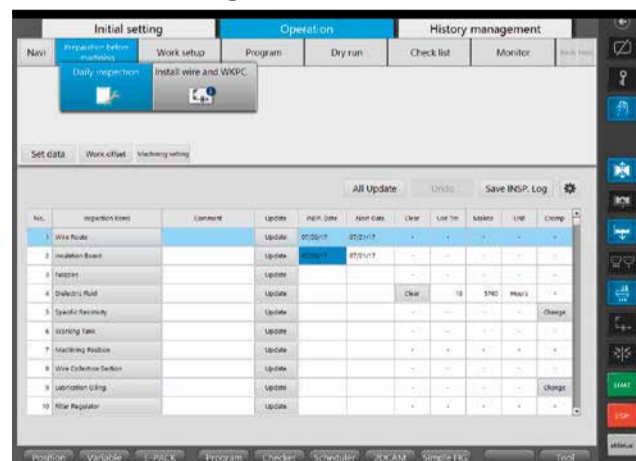

During the preparation of pending machining tasks, support is provided by overviews of the remaining wire, state of filter cartridges and deionisation resin, and other parameters. This way you can prevent outages caused by finite consumables or wear parts and optimise machine running times.

### Help at a keystroke

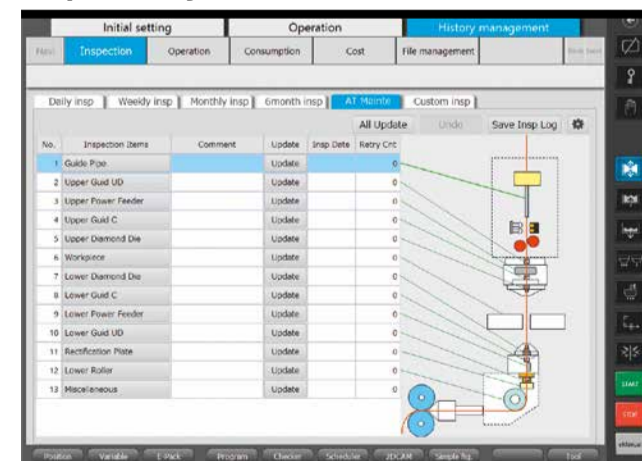

The complete machine documents inclusive of maintenance instructions are always available, and the right help is quickly found. Comprehensibility is aided by photos and 3D depiction.



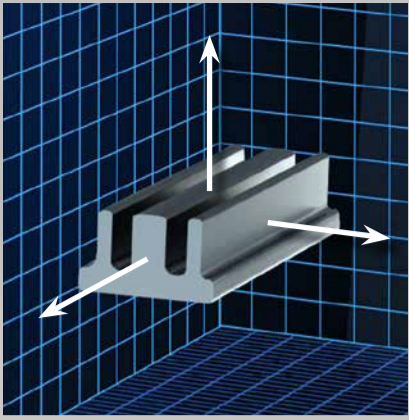

If time is of the essence or you want the machines to take some of the work off your shoulders. Set-up often takes too long; from now on, you can save this time.

Highly accurate probing cycles on the sides and corners measure the workpiece precisely. With or without jet stream or even submerged, by means of the cutting wire or with the optional 3D touch probe – just as you wish.

## Clamp it and press *Start!*

Smart user guidance, easy work set-up.



### Fully automatic alignment cycles

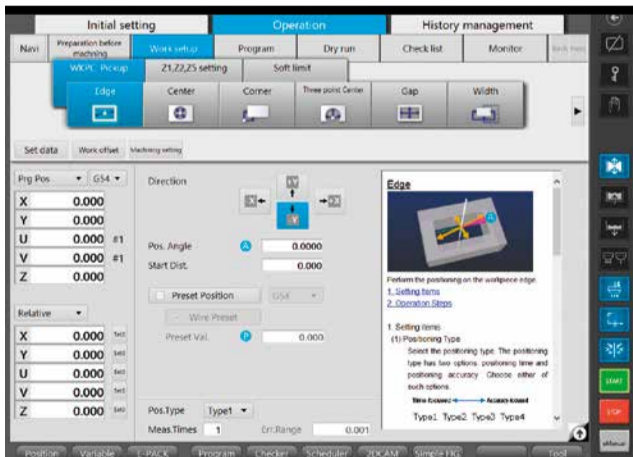

Intelligent user guidance takes you to the finish. The electrical discharge machine takes you quickly to your goal.

### Manual control



Comfortable set-up with the manual control box: standard equipment with Mitsubishi Electric. All essential control functions at hand – wherever you need them.

### 3D position measuring – manual or automatic

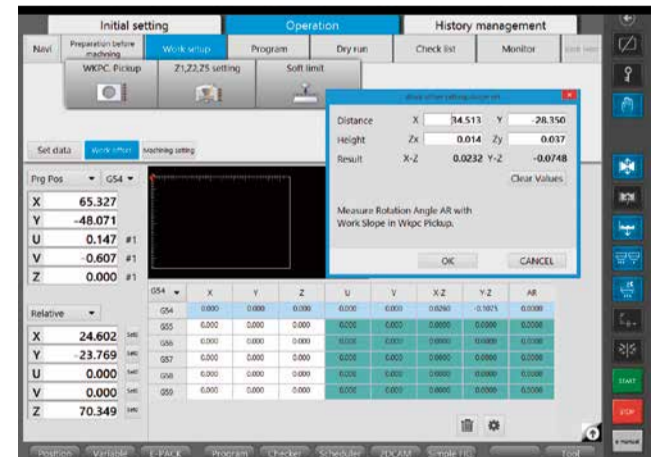

Both are possible. As a user, you decide whether you do set-up classically by hand or the machine automatically defines the position of your workpiece. Using the cutting wire or pick-up coil – the machine takes care of it for you. It only takes the press of a button.





### The inbuilt first step towards automation

Each MV-R from Mitsubishi Electric comes with the easy-to-operate job scheduler. This makes you flexible and paves the way to more extensive automation solutions.

## Job scheduler, inbuilt flexibility.

Manage, pause and resume jobs the easy way.



### Integrated job scheduling



Greater flexibility thanks to adaptable job scheduling: with the simple assignment of priorities, you can quickly respond to changing requirements and squeeze in an urgently needed part with ease. Several machining programs can be deposited in the job scheduler and managed there.

### Fast and flexible work planning

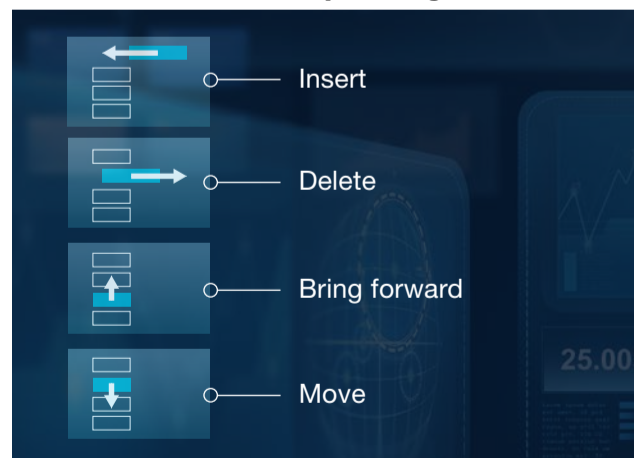

This is the easy way to add new jobs during machining or change the order of existing machining operations. The new job processing system with priority management makes it possible to amend a machining list without interrupting machining.

### Pause a job – and resume

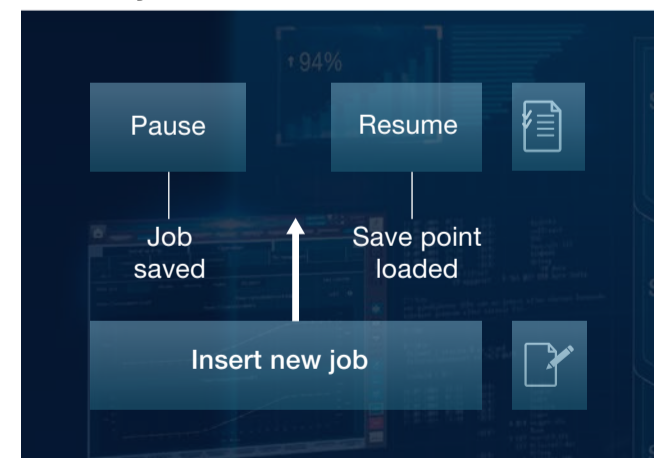

A machining process is easy to pause even in mid-flow when urgent jobs have to be processed. The control stores the current state of machining. When the inserted job has been completed, machining can be immediately resumed at the point of interruption. Pushbutton flexibility without programming effort.





## The machine that crunches numbers – so that you can maximise your profits.

### Far-sighted maintenance management

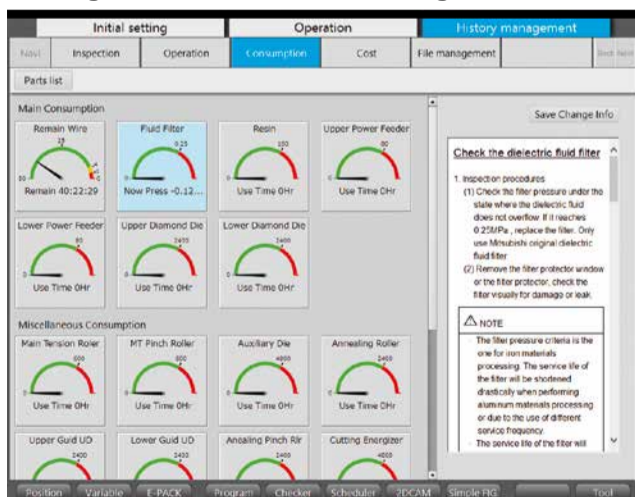

All the key consumables are monitored online and presented with their anticipated remaining life. This includes display of the remaining life of the wire spool installed in the machine as well as indication of filter pressure and, calculated from this, the probable period until the next filter change.

### Visual process management



Machine states depicted over time make capacity utilisation easier to grasp and assist forward-looking production planning. This overview is supplemented by a list of completed machining jobs and the associated machine times and unit costs.

### Analysis of operating costs

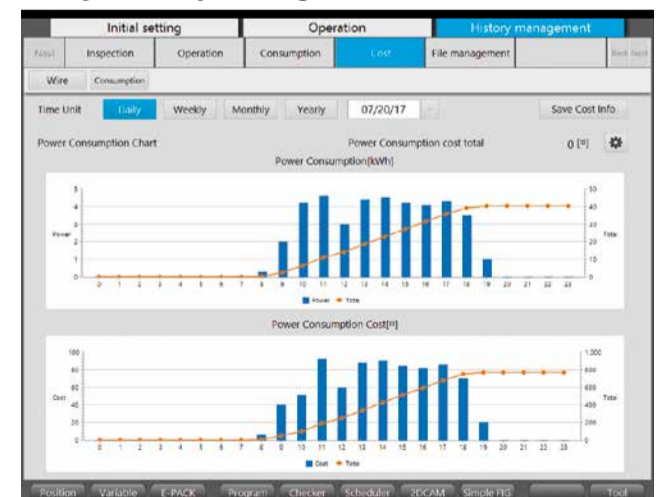

Given knowledge of unit costs and their inclusion in the machine's own analysis, records of consumption data such as energy consumption, wire consumption and component wear help with cost analysis and the costing of pending machining jobs.





## Online service for higher productivity.

Boost your transparency and simply get more out of your machine.

### After-sales service online



Rapid online help to reduce downtime and expenditure on service assignments. Applications support with direct access to the machine control can provide the machine operator with optimum and rapid assistance when faced with difficult tasks. All in the aid of improving production operations.

### Process data management



Operating and process data can be retrieved at the control. Available as standard is an export function for all process data, operating states, consumption data and maintenance states as well as alarms. This way the data from several machines can be viewed and evaluated in consolidated form, through to their integration in higher-order production management systems.

### No compromising on security



Anti-virus protection is ensured as standard by one of the world's leading software systems in security control.





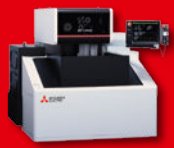

## Remote control with mcAnywhere



 Option

 **NUI**  
NATURAL USER INTERFACE

**Always up to date –**  
wherever you are.

You can control the machine and keep an eye on processes, wherever you are. Intelligent communication takes the pressure out of work. Ideal combined with automation solutions and high process autonomy with the intelligent AT wire threader.

### **mcAnywhere Service (standard on the MV-R Connect)**

Rapid help from Mitsubishi Electric experts.

### **mcAnywhere Control**

Comfortable and reliable remote control for your EDM system – powered by TeamViewer.

### **mcAnywhere Contact+**

Any time, any place ... you're always up to date with direct status reports by email. Status reports can be optionally sent by text message – a GSM modem with a suitable driver can be added for this.







**Cleaning the tank seal**

With the ingenious auto-clean function, your tank seal always stays impeccably clean. This ensures long-term precision and saves labour for the user.



0  
sec.

**Quick replacement,  
long-term savings.**



**Cutting wire replacement**

92  
sec.



Simply replace the spool and feed the cutting wire over the feed rollers. Everything ready for work again in 92 seconds.

**Rapid filter change...**

32  
sec.



...without tools or wasted time. Two hands, 32 seconds – and the filter is replaced.

**Changing the power feed contact**

5  
sec.



48-fold power contact

Replace the power feed contact with just one hand and a small gauge – at a speed befitting Formula One.



Watch film now:  
[www.mitsubishi-edm.de/spool](http://www.mitsubishi-edm.de/spool)



Straight to the movie:  
[www.mitsubishi-edm.de/filters](http://www.mitsubishi-edm.de/filters)



See for yourself:  
[www.mitsubishi-edm.de/power](http://www.mitsubishi-edm.de/power)



**Sample calculations**

Workpiece . . . . . Punch, steel 1.2379 – 100 mm cutting length  
 Cutting height . . . 60 mm  
 Surface . . . . . Ra 0.28 µm (compared to Ra 0.35 µm for conventional EDM machine)  
 Wire electrode . . . Brass, 0.20 mm

**Higher performance: Energy costs reduced by up to 69%**

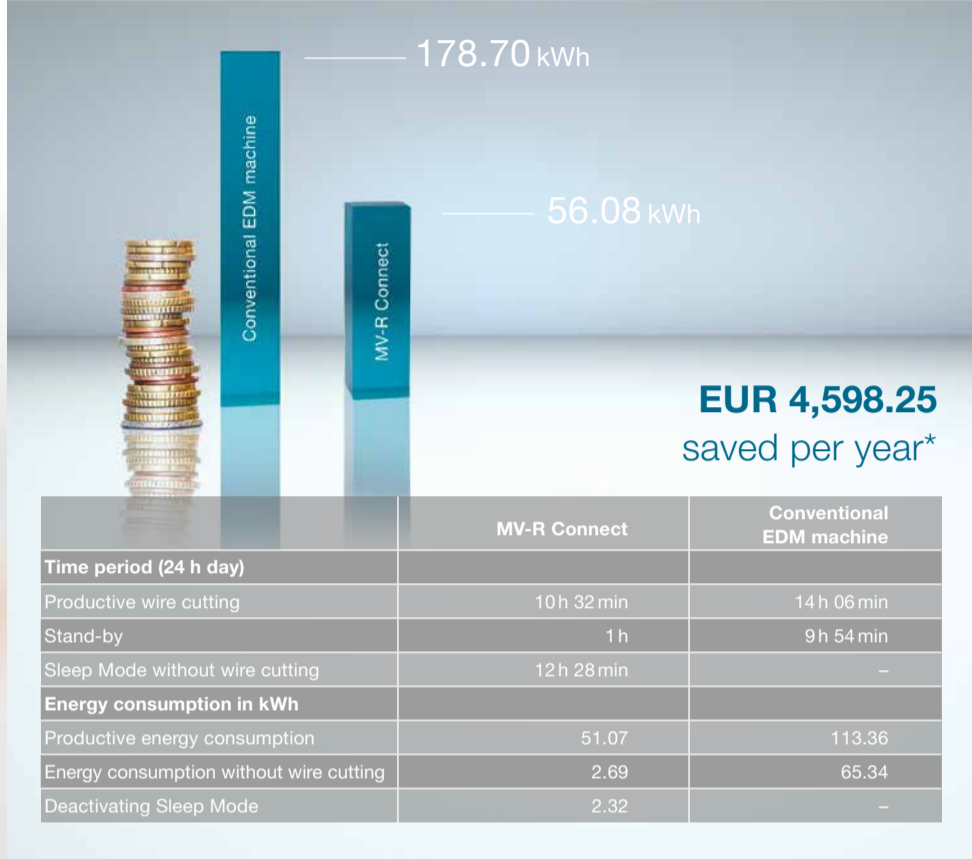

\* Assuming production of six punches per working day, electricity price 0.15 euros/kW for 250 working days/year



**Greater precision faster**  
 = lower piece costs.



**Reduce filter costs by up to 45%**

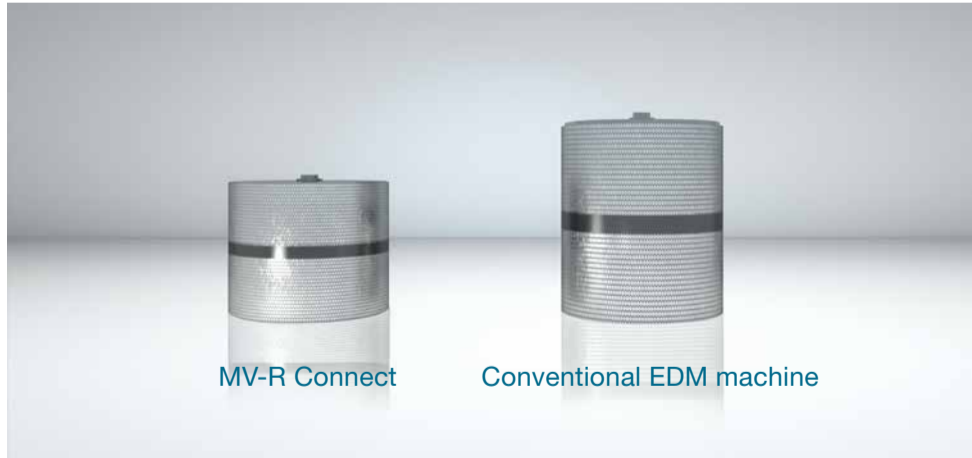

**Reduce cost of ion exchange resin**

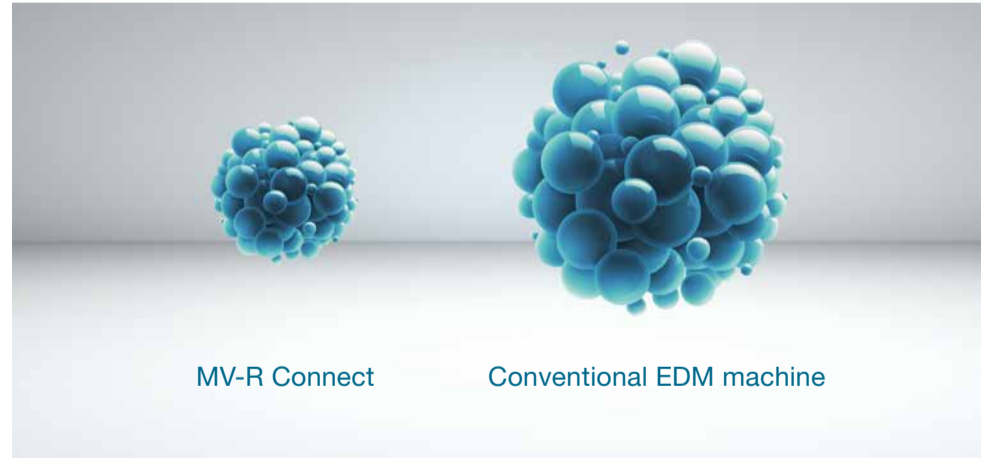

Calculate the difference online at:  
[www.edm-calculator.com](http://www.edm-calculator.com)



productivity

## Producing more, less expensively.

How it's done.



### 30.76% more productive capacity

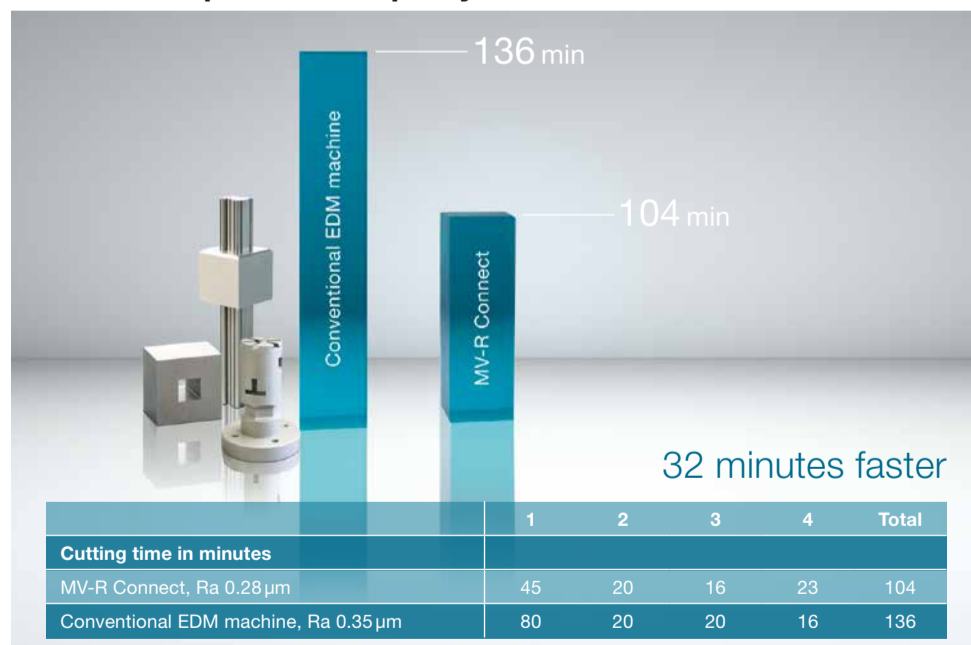



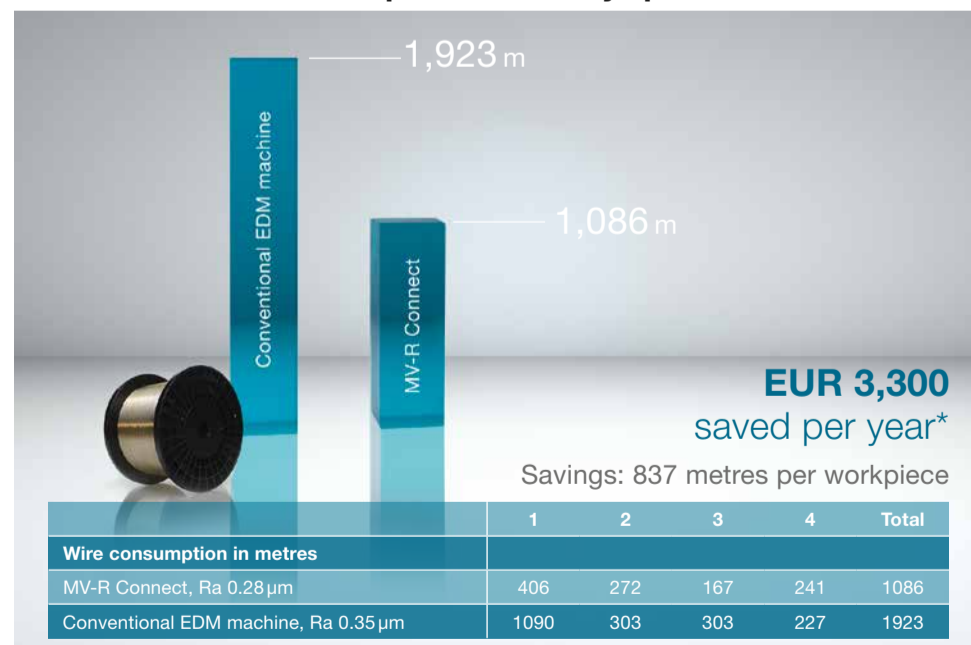

### Better result: Wire consumption reduced by up to 46%



\* Assuming production of six punches per working day, bare brass wire (0.20 mm) price 9.60 euros/kg for 250 working days/year





- 
**Digital FS**  
 Top-league technology – superfine surface finish as good as Ra 0.1 µm
- 
**Automatic water top-up**  
 Intelligent, continuous monitoring of the process water level and fully automatic top-up as required\*
- 
**Connection to external cooling system**  
 Precise temperature control thanks to microprocessor-controlled connection to a central cooling system\*\*
- 
**Automatic filter switchover**  
 Two pairs of filters can be optionally used together in the process or, when one pair of filters reaches its maximum pressure, the system switches over automatically to the second pair

\* Requires a connection to a water supply.  
 \*\* Requires a central cooling system available on customer site.

 Option

## Customised extension.

The intelligent solution.

### 3D probing



Mounted on the machine head, activated on command. The intelligent solution.

### Angle Master Advance II



Special wire guide and sequential calculation of the wire set-up point for precision angles.

### ERGO-LUX (machine lights)

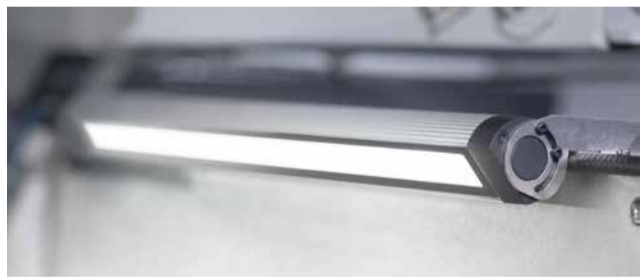

Working conditions that are kind to your eyes – for the sake of users and for the benefit of machining results.

### Tool package



Complete kit for the machining of rotationally symmetrical tools with PCD or CBN cutting edges.

### 16/20/25 kg wire station



Accommodates large wire spools with ease. (Standard equipment on the MV4800R Connect)

### Warning lamp



Machine status is visible from a distance.



From grinding wheels to high-precision cones: a future-proof machine that you can upgrade at any time.



⊕ Option

## A turn for the better.

Extend your machine's functions.

### B-axis

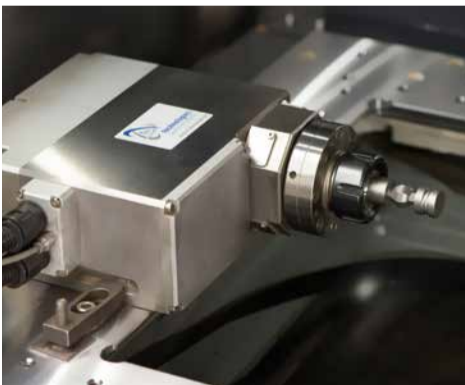

A servo-controlled B-axis fully integrated in the machine controls permits wire cutting on a rotating carried workpiece. Separation and multi-sided machining can be performed in a single clamping as well as simultaneously.

### Rotary swivel axis



Machining cones to the highest standards of precision: the rotational/swivel axis integrated in the machine controls. Multi-axis machining to the centre of the workpiece and multi-sided machining in a single clamping, plus the realisation of high-precision conical polygons.

### Mini-rotational axis



Rotating spindle fully integrated in the machine control with positioning for the most minute high-precision components, e.g. the manufacture of ejector pins with a diameter of  $\geq 0.05$  mm, the realisation of conical threads in medical technology, erosive grinding, turning and simultaneous machining.

### Rotational machining



Can be used for reliable indexing and simultaneous machining as well as high-speed rotation (EDM grinding): the servo-controlled rotational machining fully integrated in the machine controls. Discover new production scope!





## Automation has to be flexible.

Reconciling different brands.

### Optimum solutions – customised, configured or standardised

The handling systems and robots from different manufacturers can often be seamlessly integrated. Renowned for their dependability and productivity, the EDM machines of the MV-R Series from Mitsubishi Electric are automation-ready. We'd be happy to show you examples that have proven effective in practice and help you to cut costs and boost your productive capacity.



Handling equipment from different manufacturers – welcome and easily integrated.



Flexible solution: Articulated-arm robot up to 15 kg of Mitsubishi Electric quality.



Automated integration – here with ZK Chameleon.





**Achieving results with greater accuracy due to maximum precision**



Watch film now:  
[www.mitsubishi-edm.de/mastered](http://www.mitsubishi-edm.de/mastered)

## Successfully mastered!

The key to success in a wide range of fields.

Medicine · Vehicle industry · Communications/electrics · Aerospace

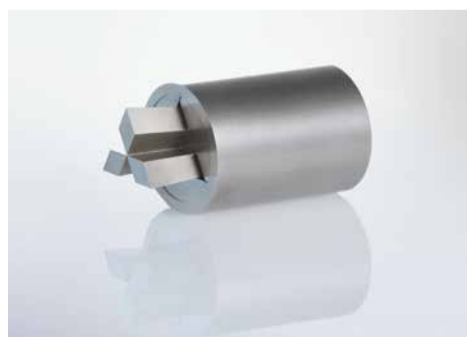
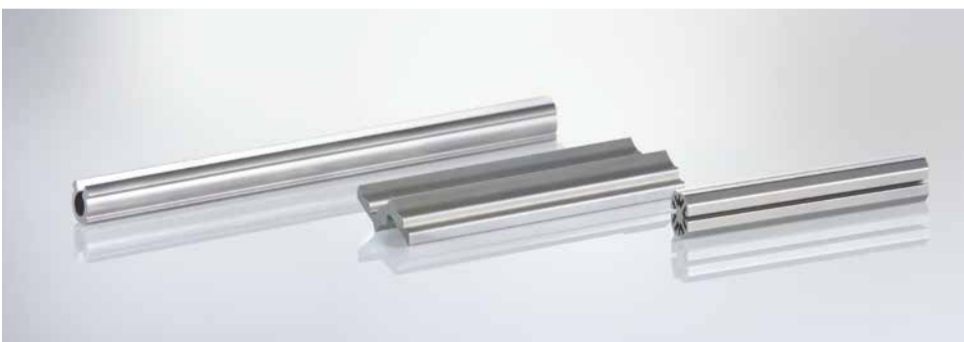

Experience it with your own eyes:  
[www.mitsubishi-edm.de/core](http://www.mitsubishi-edm.de/core)



**Service hotline: +49 (0) 2102 486 7600**  
**Application support: +49 (0) 2102 486 7700**  
Monday to Friday: 7.30 am to 8 pm / Saturday: 9 am to 4 pm

## Service.

We're there to help you.

You don't like call centres and queuing systems? We don't either. With every Mitsubishi Electric EDM system you buy excellent service as part of the package. Service is performed by our own highly skilled service technicians so that production is kept dependably up and running. Users are assisted over the phone and benefit from the expertise and wealth of experience of Mitsubishi Electric specialists.

### Warehousing and logistics



We supply all in-stock products (wear and spare parts) even outside normal business hours, e.g. by courier or collection. Our proximity to Düsseldorf Airport and motorway links enables us to ship parts at high speed.

### Original Mitsubishi Electric parts



All standard spare parts of the Mitsubishi Electric consumables line are original imports or fabricated in Germany in accordance with the development and design specification. You receive original parts of immaculate quality at attractive prices.





## Training.

Helping you to stay up to date.

### Training



Users learn skilled operation right at the machine and at specially configured CNC workstations. This way you benefit most from a direct transfer of expertise. Training is available at the facilities of Mitsubishi Electric in Ratingen, Germany. Additionally, training courses are provided by our international partners.

### Training centre



Training on our wire-cutting and die-sinking systems takes place at our own technology and training centre in Ratingen.

### Courses, seminars and user workshops

The varied programme covers everything from basic knowledge through to customised training geared precisely to your employees' learning needs. In addition, we also hold regular applications workshops – free of charge to our customers – which always deal with current topics in theory and practice.

### Equipment and instructors

Our skilled instructors introduce you to our EDM systems in theory and practice. The training facilities are appointed with the latest technology, CNC simulators and peripheral equipment.

### Certificates

All training participants receive a certificate on completing a course.

**MV1200R  
CONNECT**

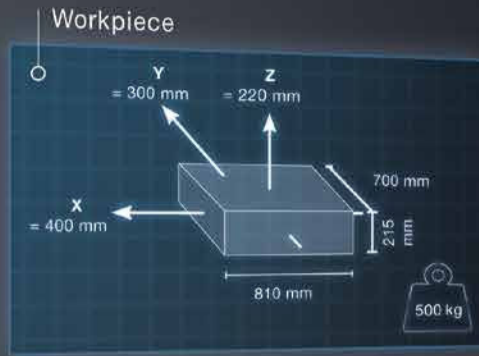

Machine weight ..... 2700 kg  
 Generator weight ..... 240 kg  
 Machine height ..... 2015 mm

Required minimum dimensions for  
 Door/Gate passageways (w x h)... 1910 x 2015

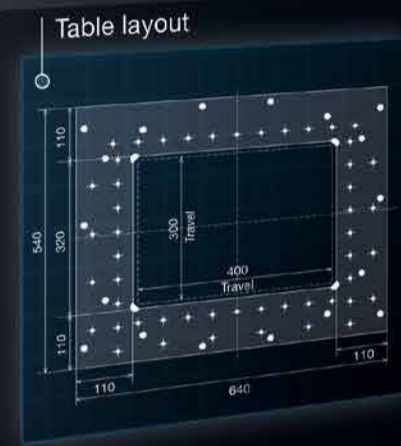
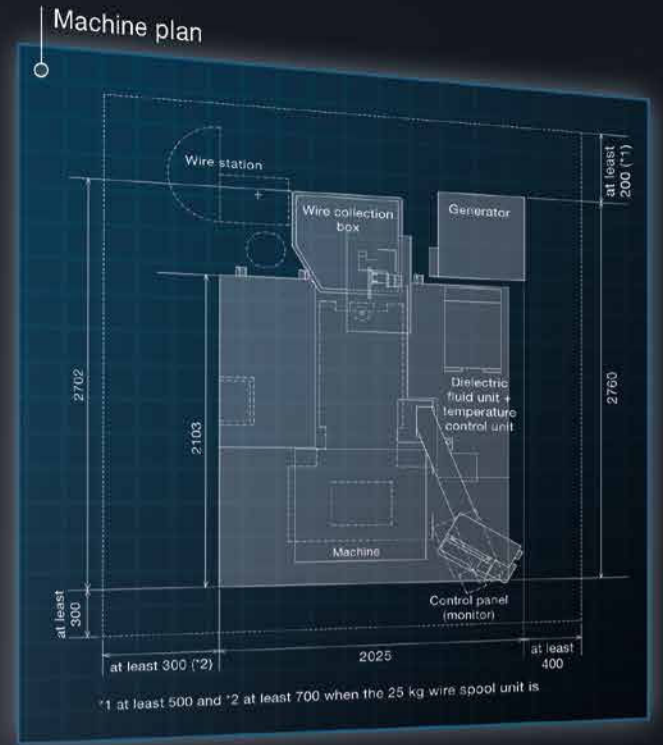

**MV2400R  
CONNECT**

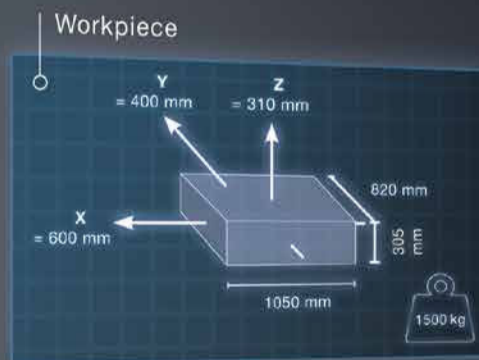
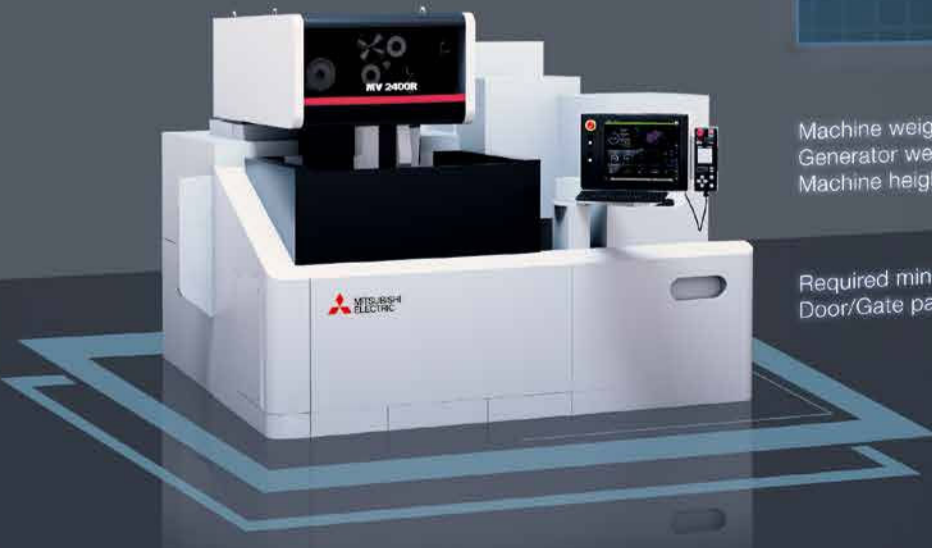

Machine weight ..... 3500 kg  
 Generator weight ..... 240 kg  
 Machine height ..... 2150 mm

Required minimum dimensions for  
 Door/Gate passageways (w x h)... 2022 x 2150 mm

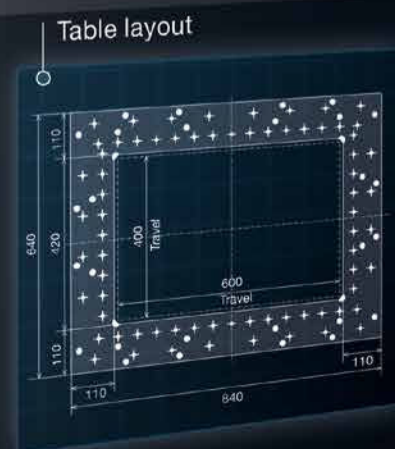
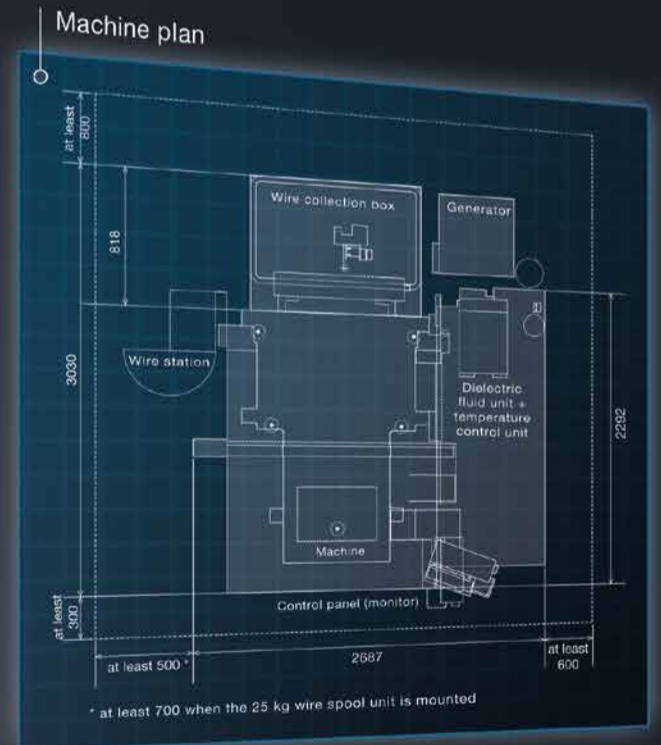



**MV2400R Z+  
CONNECT**

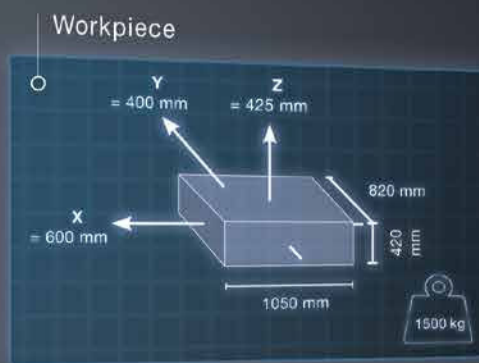
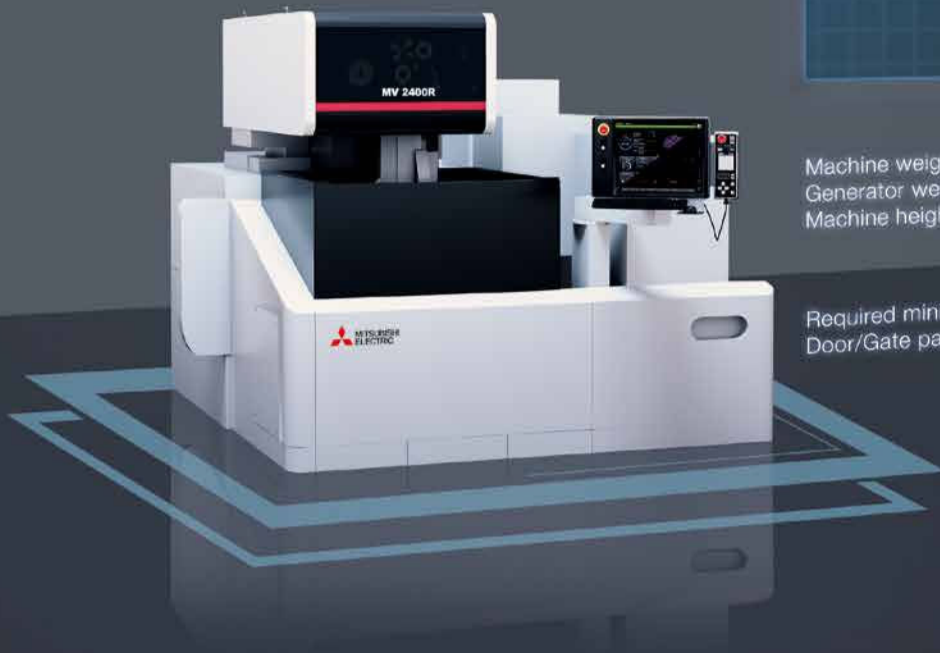

Machine weight ..... 3650 kg  
 Generator weight ..... 240 kg  
 Machine height ..... 2380 mm

Required minimum dimensions for  
 Door/Gate passageways (w x h) ... 2022 x 2380 mm

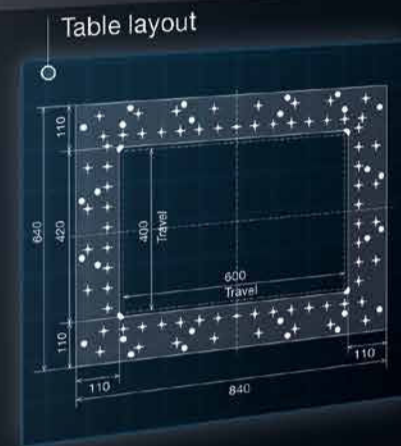
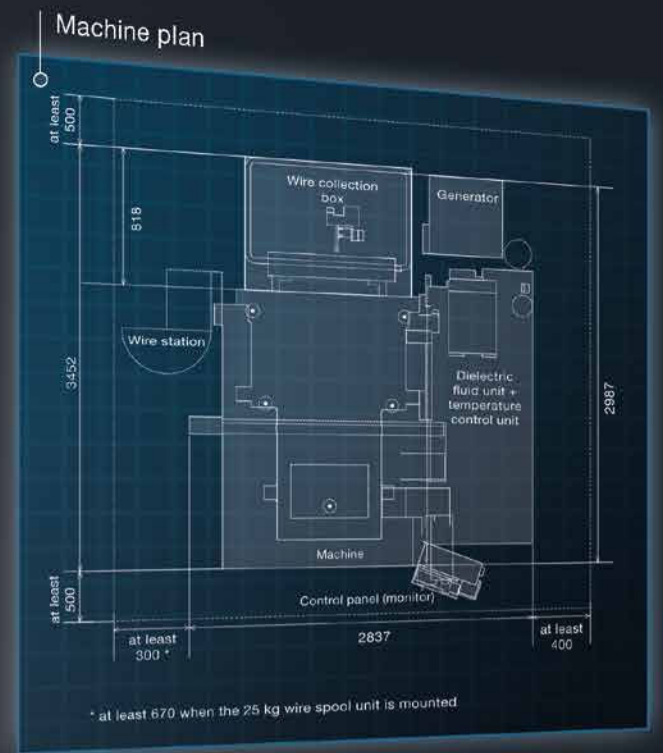

**MV4800R  
CONNECT**

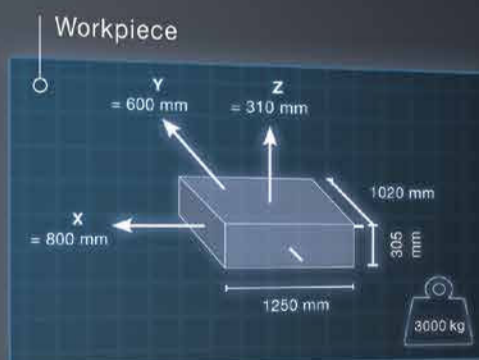
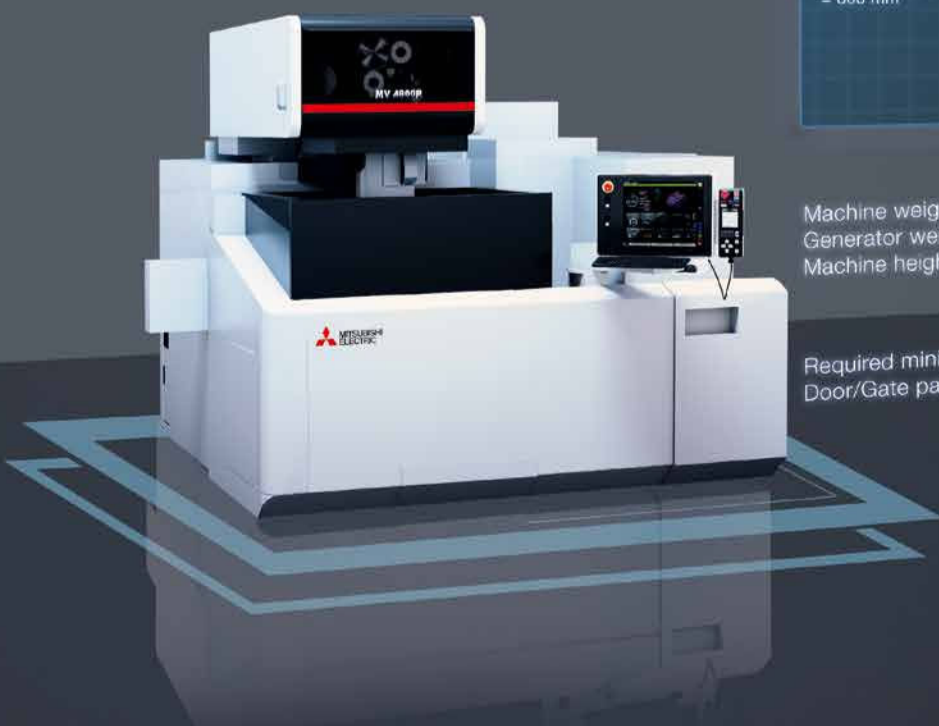

Machine weight ..... 5600 kg  
 Generator weight ..... 240 kg  
 Machine height ..... 2415 mm

Required minimum dimensions for  
 Door/Gate passageways (w x h) ..... 2587 x 2415 mm

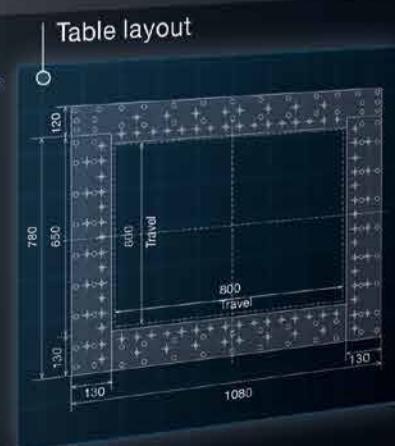
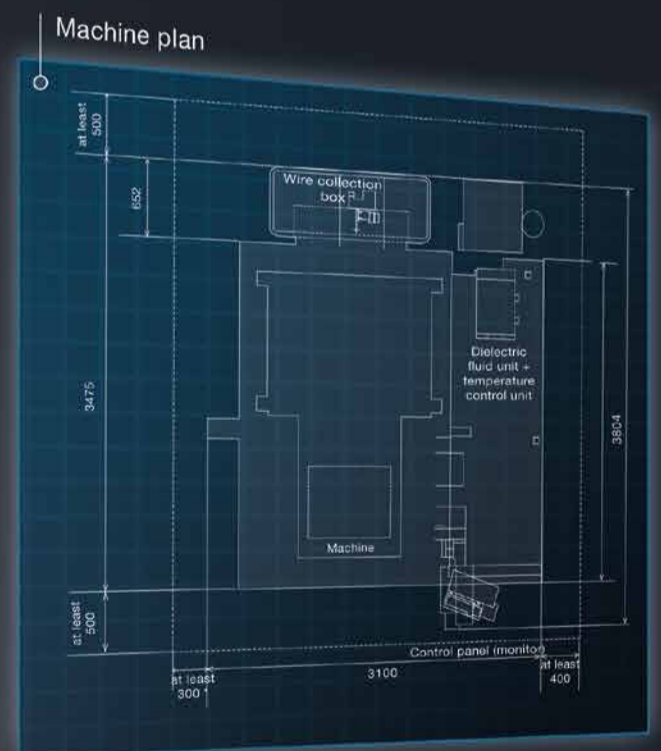



Machine	MV1200R	MV2400R	MV2400R Z+	MV4800R
Travel (X/Y/Z) in mm	400/300/220	600/400/310	600/400/425	800/600/310
Travel (U/V) in mm	120/120 (+/- 60)	150/150 (+/- 75)	150/150 (+/- 75)	150/150 (+/- 75)
Taper angle (workpiece height) in °/mm	15/200 30/87	15/260 30/110	15/260 30/110	15/260 30/110
Max. workpiece dimensions (WxDxH) in mm	810x700x215	1050x820x305	1050x820x420	1250x1020x305
Max. workpiece weight in kg	500	1500	1500	3000
Table dimensions (WxD) in mm	640x540	840x640	840x640	1080x780
Table layout	Hardened 4-side frame table			Hardened 4-side table
Possible wire diameters in mm	0.1–0.3			0.15–0.3
Wire spool capacity in kg	10			10/16/20/25
Automatic wire threader / wire chopper	Yes / Yes			
Overall dimensions (WxDxH) in mm	2025 x 2760 x 2015	2687 x 3030 x 2150	2837 x 3452 x 2380	3100 x 3475 x 2415
Machine weight in kg	2700	3500	3650	5600
Mains voltage	3-phase 400 V/AC ± 10%, 50/60Hz, 13kVA			
<b>Filter system</b>				
Tank capacity in l	550	860	980	1480
Filter particle size in µm / filter elements	3/2			
Temperature control	Dielectric cooling unit			
Weight (dry) in kg	Included in machine weight	350	390	450
<b>Generator</b>				
Power supply unit	Regenerative transistor pulse type			
Cooling method	Fully sealed / indirect air cooling			
Max. output current in A	50			
Dimensions (WxDxH) in mm	600x650x1765			
Weight in kg	240			
<b>Control</b>				
Input method	Keyboard, USB flash drive, Ethernet, 19" touchscreen			
Control system	CNC, closed circuit			
Min. command step (X/Y/Z/U/V) in µm	0.1			
Min. axis resolution in µm	0.05			

Equipment	MV-R Series
Tubular Shaft Drives with linear scales (X/Y/U/V)	Yes
Control M800 with 19" full-touch monitor	Yes
Hand pilot with configurable LCD monitor	Yes
Automatic vertical front door	Yes
Digital AE II generator	Yes
Fine finishing generator H-FS	Yes
Hardened 4-side frame table	Yes (MV4800R: hardened 4-side table)
Digital electricity meter / filter pressure sensor	Yes
Ethernet/DNC/FTP	Yes
Preparation for automation	Yes (not available for MV4800R)
McAfee AntiVirus embedded	Yes
Operating data output	Yes
3D CamMagic on-board	Yes
Corehold technology	Yes
Job scheduler	Yes
Sleep mode	Yes

Optional hardware	MV-R Series
Digital fine finishing generator D-FS	Optional (not retrofittable, not available for MV4800R)
Thin wire specification 0.05 / 0.07 mm	Optional (not retrofittable, not available for MV2400R Z+ and MV4800R)
Wire station for 16 / 20 / 25 kg wire spools	Optional (standard for MV4800R)
Wire station for 50 kg wire spools	Optional
Angle Master Advance II – basic kit incl. aligning device	Optional
Angle Master Advance II – Wire guide kit	Optional
Automatic Renishaw probe	Optional
ERGO LUX LED floodlight	Optional
Tricolour status lamp	Optional
Automatic dielectric water refilling	Optional
Connection to external cooling system	Optional
External signal output with relay board	Optional
Filter switching system	Optional

Optional tools	MV-R Series
mcAnywhere Service	Yes
mcAnywhere Control / mcAnywhere Control light	Optional
mcAnywhere Contact / mcAnywhere Contact light	Optional / Yes
Tool package / automation solutions	Optional

Power connection: 3-phase 400V/AC, PE, ± 10%, 50/60Hz, primary fuse 32A slow

Pneumatic connection: 5–7kgf/cm<sup>2</sup>, 500–700kpa, minimum air flow rate 75l/min, 3/8" hose connection

The EDM system should be set up on a suitable hard industrial floor and preferably on a consolidated concrete floor. Any shielding that may be necessary in conformity with the EMC Directive is not included in the equipment supplied by Mitsubishi Electric.

The cooling unit contains fluorinated greenhouse gas R410A. For further information, please refer to the associated operating instructions.



Details can be found in the assembly plan of the machine:  
[www.mitsubishi-edm.de/download](http://www.mitsubishi-edm.de/download)



Partners

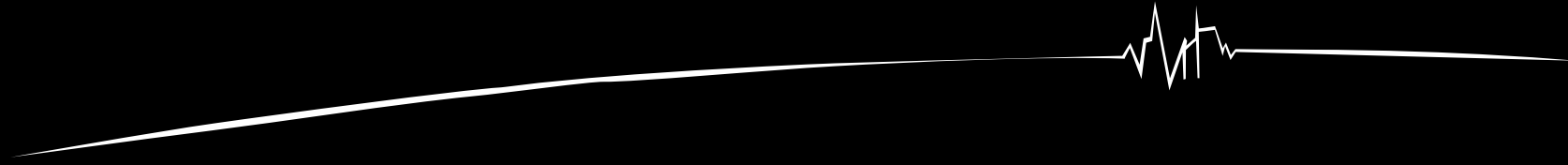

**MITSUBISHI ELECTRIC EUROPE B.V.**

Mechatronics Machinery / Mitsubishi-Electric-Platz 1 / 40882 Ratingen / Germany / Tel. +49 (0) 2102 486-6120 / Fax +49 (0) 2102 486-7090  
edm.sales@mee.com / www.mitsubishi-edm.de



EN Subject to technical change and error / 23.03.2020 / Art. No. 472344  
Details of image rights, trademark rights and other legal notices at [www.mitsubishi-edm.de/notices](http://www.mitsubishi-edm.de/notices)