

The Art of *Economy*

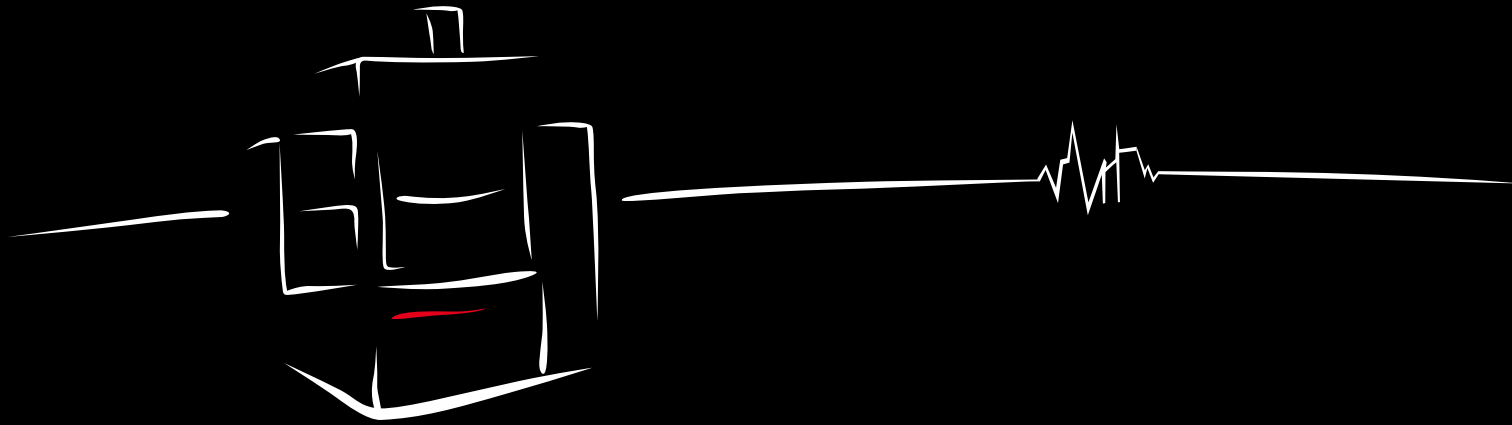

Die Sinking

Power for Precision



SG-R SERIES

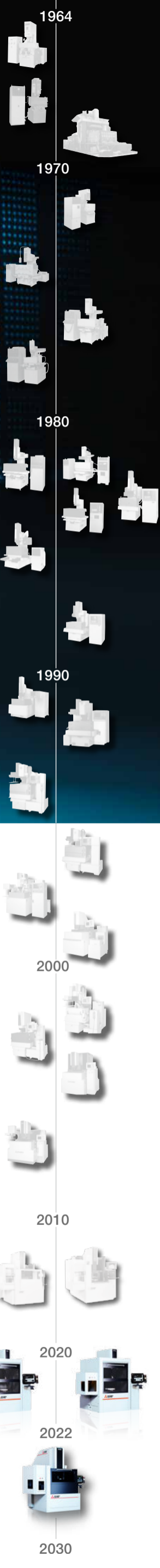

35 model series since 1964

An assurance of innovation and dependability

Mitsubishi Electric	5	Highlights	7
Functions and construction			
Construction	13	Ease of operation	25
Model SG8R	15	Programming	27
Generator technology	17	Smart user guidance	31
Nano Pulse Circuit	19	Remote control	33
Application examples	21	CNC control	35
Dialogue-assisted	23		
Efficiency/options/services			
Extras included	37	Service	45
Optional extras and special materials	39	Trainings	47
Automation	43		
Specifications			
Core data	49	Technical data	55



If you've got grand designs,
you need someone strong you can count on



Since 1970, a growing number of European companies have therefore been turning to high-performance EDM machines from world market leader Mitsubishi Electric.

Only by producing components in-house it is possible to tailor them perfectly to the intended task. Mitsubishi Electric resorts to its own controls, semiconductors, motors and other items, which are adapted in detail to all requirements. The only thing you notice is that it works – and often for many decades after purchase.

If you want to invest soundly in a durable EDM machine, choose **Mitsubishi Electric**.



Ahead of the competition

With the best price-performance ratio

The rock-solid machine base of the SG-Series is your assurance of precision and durability. The choice of high-class components ensures the long-term reliability of the machine system.

The simplicity of the control and the programming itself – a hallmark of EDM machines by Mitsubishi Electric – allows the operator to focus on the essential, i.e. the proper planning of the various eroding tasks. And here, too, this is aided by the intelligent control strategy with integrated job planning and an efficient evaluation of a wide range of operating data, including actual job costing.

The full standard equipment of the SG-R completes the package. A fire extinguishing system, C axis with a zero-point clamping tool, external programming software – all this is part of the standard equipment. Additional useful features enable you to tailor the configuration to your individual requirements.



© eroprázisa



Maximum precision

- ... ensured by solid machine manufacture and
- dual measuring system/linear scales in all axes
- active temperature compensation
- high-precision, integrated axes

Continued on page 13



Implemented all-rounder

The heart of the SG-R is the GV80 generator with 80 A peak performance – optionally 120 A. **Both are ideally equipped for any task:**

- Maximum performance and minimum wear with graphit electrodes
- efficient machining of cemented carbide
- machining of titanium, PCD and other special materials

Continued on page 17



The many advantages of the SG-R

Technology from a single source

No compromises: everything from a single source



CNC control, generator electronics, axis amplifier, inverter, motors – all from our own production. Reliable technology from Mitsubishi Electric.

1.6 G – 20 m/min

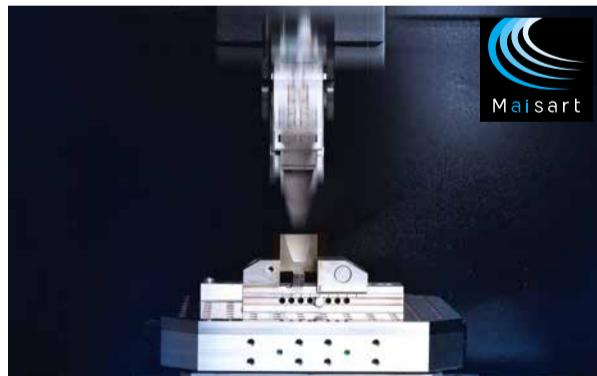

Acceleration of up to 1.6 G and travel speeds of up to 20 m/min enabled by the modern drive unit of the Z axis. The in-house AI technology uses the advantages of these values perfectly. Inclusive of safety: collision protection in all axes.

Maisart – Artificial Intelligence in EDM-Technology

The D-CUBES control generation excels with the Artificial Intelligence developed by Mitsubishi Electric.

- Forward-looking machine strategies
- Self-learning process optimisation
- Ongoing adjustment of the parameter settings

More productivity, less wear... EDM can be so simple.

Continued on page 25



Data Management 4.0

The SG-R offers various tools for data analysis

- Eroding times precalculated? IT CAN!
- Complete operational data analysis? IT DELIVERS!
- External data processing? SUPPORTED!

All this is included in the machine's standard equipment. Your efficiency is our top priority.



Integrated job planning

Greater flexibility thanks to adaptable job planning

- Simple assignment of priorities
- Insertion of urgent programs
- Inclusive of external programming system

The perfect preconditions for simple automation.

Continued on page 25





Boosting productivity with IDPM.

The Power Master of sinker erosion reconciles opposites:

- Maximum processing speed
- Minimum wear

Continued on page 17



40 % faster.

Up to 40 % faster thanks to precision axis movements:

- rapid lift-off and lowering,
- optimal immersion at the contact surface,
- powerful flushing in deep rib geometries.



Operation made easy. For the user.

Dialogue-assisted programming helps you achieve your goal with ease.

- User-friendly, plain-language dialogue
- Simple selection of machining technology
- Automatic assignment of the machining strategy
- External programming software (included at no extra cost)

Continued on page 23



The master of materials

Equipped for every application

Achieve best results in steel, carbide, titanium, PCD/CBN and many more

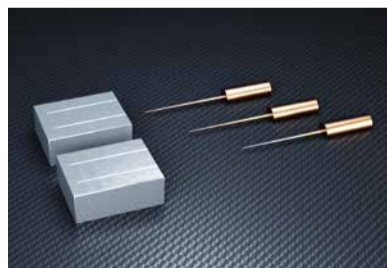
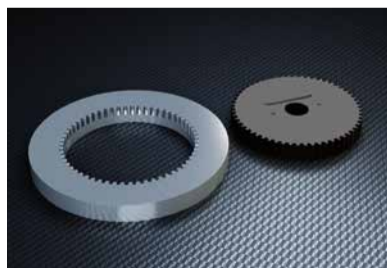
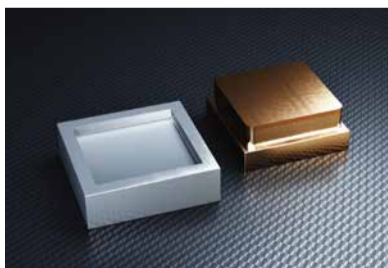
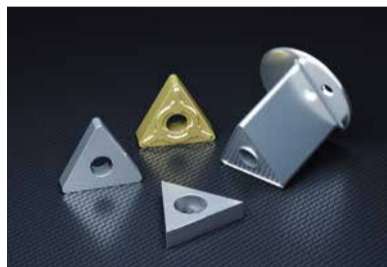

Set-up is child's play.

The graphically structured user interface for set-up of the workpiece and electrode takes the effort out of preparation of upcoming EDM jobs. In addition, the explanatory online help is in view at all times.

Continued on page 31



The EDM system that makes your business profitable.

The SG-R brings you the future. Your competitiveness is enhanced by

- performance and precision,
- solid, durable, low-maintenance construction.



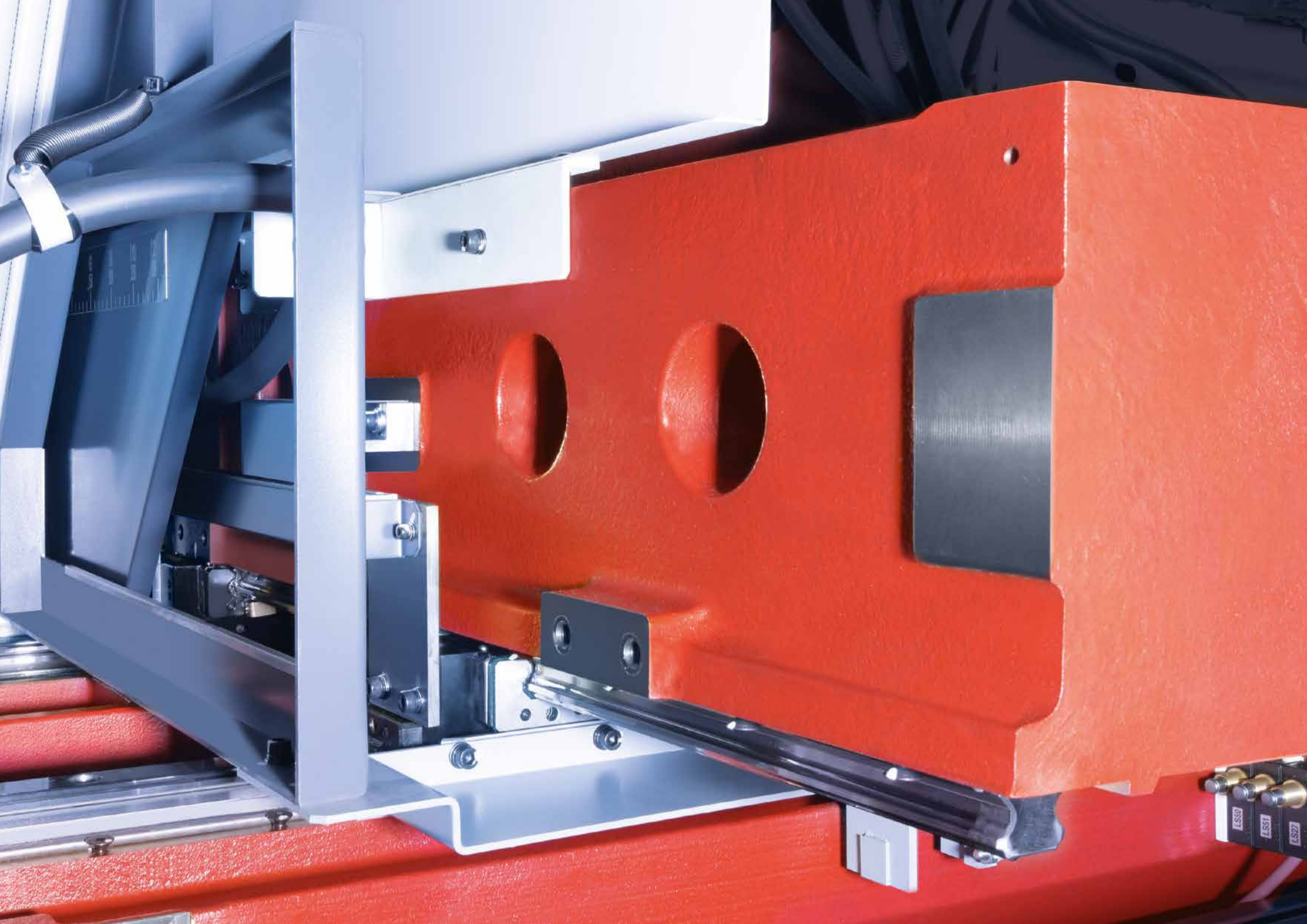

Solid cast steel

for maximum agility, dynamics and precision

Precise axis movements – whatever the loading

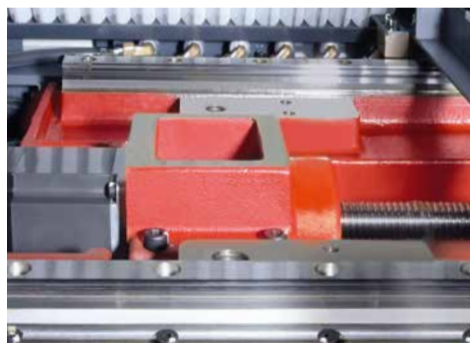

Rock-solid machine build, exactly as it should be. Sophisticated, cleaned up and absolutely durable. These principles are well proven for decades and will be casted into each and every new machine. The use of high-class components inclusive.

In-built „just right“ factor



On the SG-R series, maximum precision is naturally built in – with linear scales on the X, Y and Z axes and advanced temperature compensation, the effects of room temperature fluctuations are measurably minimised.

Ergonomic workplace



Good accessibility thanks to the three-sided lifting tank allows convenient and quick set-up. The precision-ground work table at an ergonomic height is equipped with standard T-slots. For loading by crane, the casing on the top is easily opened.

Compact

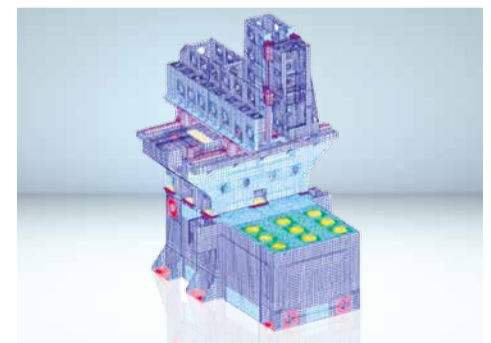

Rock-solid machine construction, executed with the focus on high precision. A compact design is achieved through the concentrated use of materials matching the traverse paths. The high dynamics of the Z-axis are made possible by the robust design of the machine head.

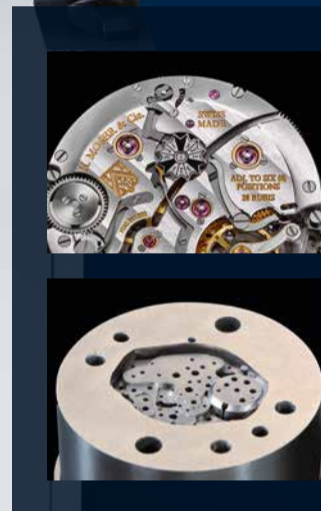

The optical industry, microelectronics, medical technology applications – this is where the SG8R is in its element. The clear and distinct focus on highest precision and finest details is reflected in the detailed equipment of this machine system.

No compromising on the generator or technology – even when it comes to the finest details, performance stays at the highest level.

The SG8R: tiny, intricate, exquisite

Extreme precision tailored to the finest details

Short travel paths – robust components

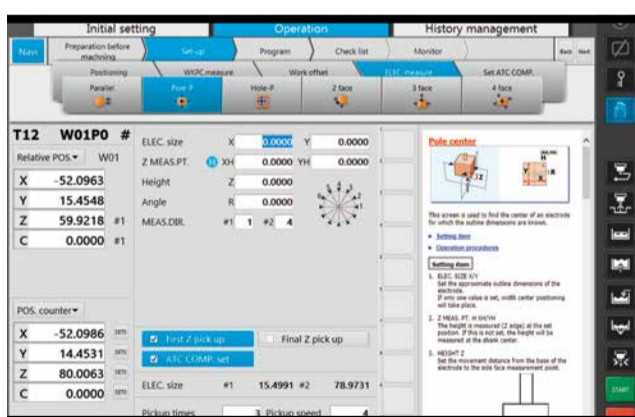

Designed for maximum accuracy and attention to detail, the SG8R has the same high-quality components in its machine engineering as its big sister. No compromises – even when it comes to small loads and short distances. Everything with the focus on precision in detail.

The worktable – granite for the toughest requirements



The worktable of the SG8R is made of granite. Due to low electrical capacitance, it permits precise feedback and optimisation of the generator pulses, especially at low currents in micro-machining. Basically, granite with its special properties ranks as the optimal material for precision machine construction: high rigidity, no internal stresses and a high degree of damping capacity assist precision machining in die-sinking EDM. With its dynamic axis movements and high acceleration forces die sinking requires a rigid machine design – the granite working table supports the precision within the last microns.

HGM, NP2, LLTX – important acronyms when it comes to finishing



The generator stages for fine finishing with fine currents and high frequencies. NP2 for the finest surface finishes in the range down to Ra 0.1 μm, HGM for high-gloss machining and LLTX for the lotus leaf effect on mould surfaces – all these technologies are supported in their functionality by the SG8R through the low electrical capacitances of the granite worktable. Uncompromising for the highest level of finish.



Watch now:
www.mitsubishi-edm.de/idpm-en

The generator with 80 amp standard (120 amp optional)

Developed for superlative performance, with plenty in reserve



The GV generator is designed for a wide range of applications. Superlative performance with extremely low electrode wear by using graphite electrodes is possible as well as the creation of intricate details and high surface qualities with copper. The generator is just as suitable for machining carbides as for machining titanium and many other materials.

KI + IDPM – the key to success

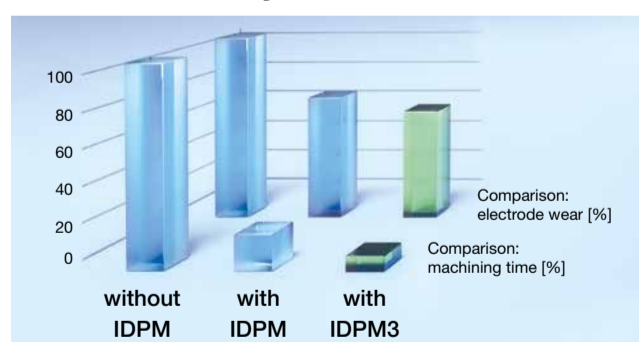

The digital Power Master IDPM guided by Artificial Intelligence is the key to the SG-R's outstanding performance. Minimal wear of the graphite electrodes combined with high removal rates is visibly supported by this technology. The formation of deep ribs with a uniform surface structure is another feature of the new IDPM with AI. The IDPM's high performance available not only for the machining of steel but also of carbide.

40% more speed

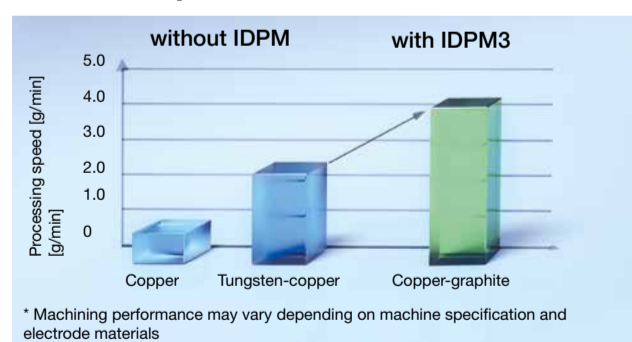

Significant improvement of the removal rate over conventional machines: up to 40 % higher machining speed can be achieved with carbide – thanks to the new IDPM. The use of copper-infiltrated graphite significantly increases the removal rate. The finish with tungsten copper electrodes compensates for slightly higher wear – performance and precision combined. Also in carbide.

Energy efficiency integrated

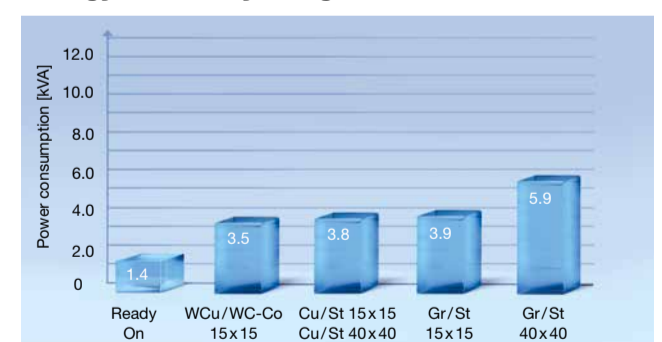

The GV-Generator is geared for minimal power loss and thus energy efficiency. This reduces energy costs while at the same time increasing power output and competitiveness – profit-generating technology from Mitsubishi Electric.



Racing car
Alfa Romeo F1® Team ORLEN C42



Top-tier technology

Nano precision not only in tungsten carbide



Response time is decisive

Lower energy input ensures better and sharper edges. Microcracks in the material are minimised at the same time. The improved structural integrity results in significantly extended tool life, not only for forming tools.

Microcracks in carbide? No thanks!

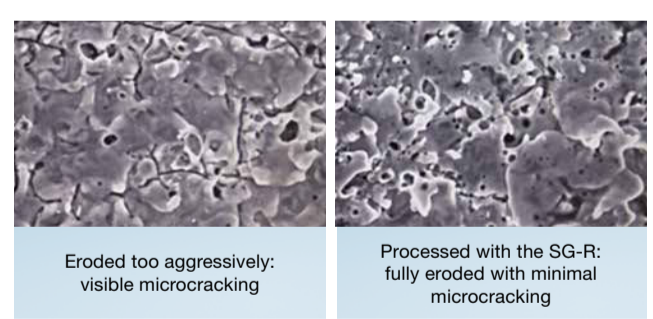

Despite its high power density, the technology of the SG series is designed for gentle material machining. Even when machining carbide with high currents in roughing operations, there is scarcely any microcracking. The service life of the machined components is thus significantly extended.

The nP Circuit

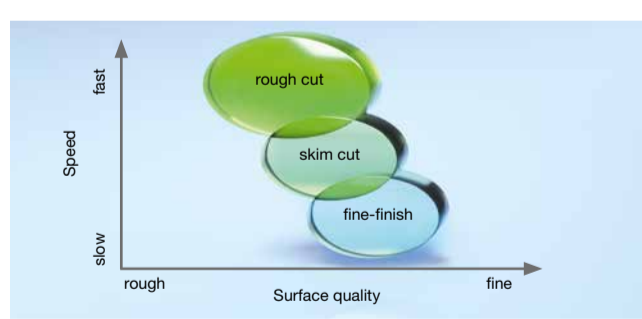

The various units of the generator are adapted to each other in such a way that both a high removal rate and a superlative surface finish can be achieved, especially in carbide. The nano-pulse fine finishing stage produces the most finely structured surface with rapid, fine sparks. Short. Fast. Nano.

HPS generator stage for PCD/ CBN processing

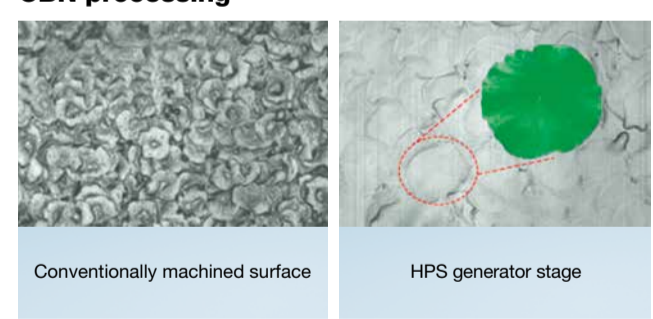

The SG-R is the master of materials that even materials such as PCD and CBN cannot withstand. With the HPS circuit, machining of PCD, CBN and conductive ceramics is possible.



Electrode: 2 x ELLOR50

Workpiece: 1.2379
 Depth: 20 mm
 VDI: 23
 Total time: 1 hr 47 min
 Wear: 0.008 / 0.000 mm



Watch film now:
www.mitsubishi-edm.de/graphite

Built for top performance

Achieving results quickly and with low wear

Mould making, aerospace, medical technology

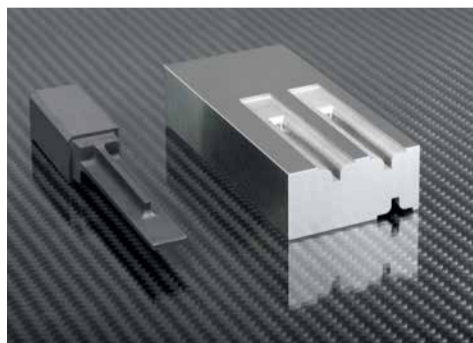

Electrode: 1 x ELLOR50
 Workpiece: 1.2379
 Depth: 30 mm
 VDI: 24
 Total time: 1 hrs 34 min
 Wear: 0.019 mm

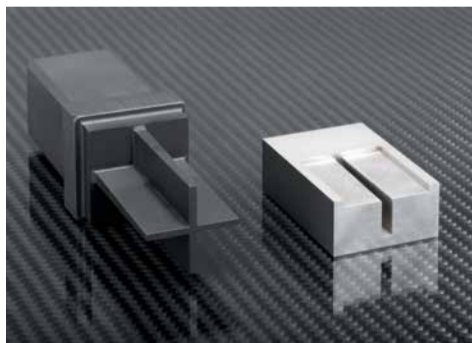

Electrode: 2 x TTK-50
 Workpiece: 1.2379
 Depth: 25 mm
 VDI: 25
 Total time: 2 hrs 43 min
 Wear: 0.044 / 0.000 mm



Electrode: 2 x ELLOR50
 Workpiece: 1.2379
 Depth: 20 mm
 VDI: 23
 Total time: 1 hrs 47 min
 Wear: 0.008 / 0.000 mm

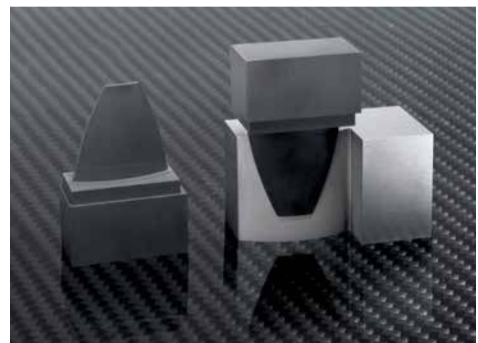

Electrode: 2 x ELLOR50
 Workpiece: 1.2379
 Depth: 30 mm
 VDI: 19
 Total time: 4 hrs 50 min
 Wear: 0.103 / 0.030 mm

Masterpiece of intelligence – the control for more comfort



Dialogue-assisted navigation

Fast track to the perfect result



Slim ergonomic manual control box



The ergonomically designed, intelligent manual control box unites all the relevant functions for regular operation and set-up in a single unit. The integrated LCD display can be individually configured by the operator. Inclusive of buttons for driving all 8 possible CNC axes.

Multi-touch display with gesture control

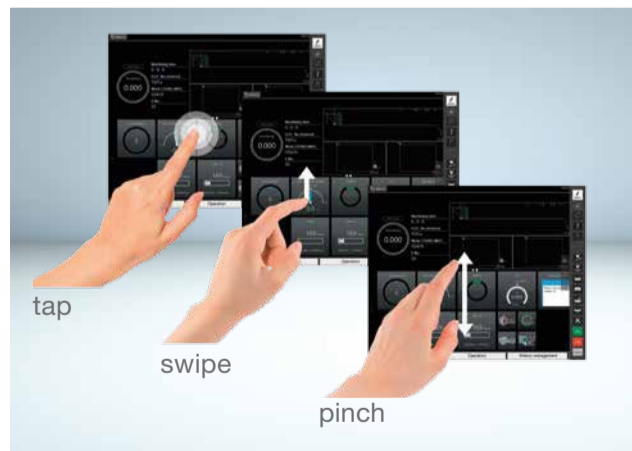

Intuitive operation from the large screen with modern gesture control boosts comfort, while the configurable user interface supports the user by allowing the main functional elements to be freely arranged during daily work.

An easy start thanks to dialogue guidance



With step-by-step dialogue guidance, less experienced users are piloted through the entire process, from programming through to the start of machining. Checklists make it possible to review all process-relevant settings and machine states so that machining yields the best possible results without interruption.



Everything under control

Achieving results faster with intelligent helpers



Integrated job planner



Greater flexibility thanks to adaptable job planning: with the simple assignment of priorities, you can quickly respond to changing requirements and squeeze in an urgently needed part. Several machining programs can be conveniently managed in the job planner.

Advance calculation of machining time

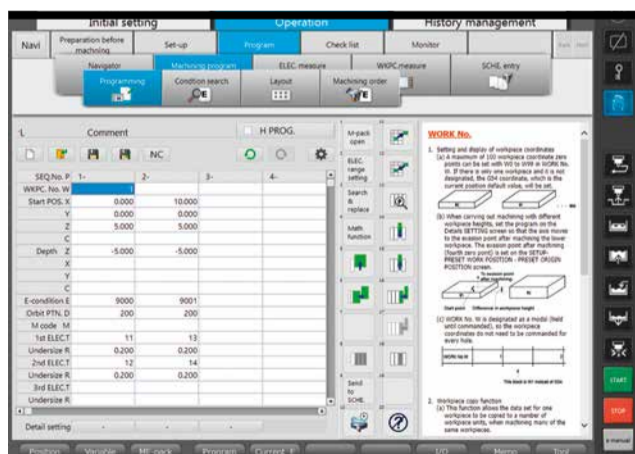

Thanks to new algorithms and the use of Artificial Intelligence, machining times can now be calculated much better in advance. The control system “learns” continuously during various machining operations and thus improves the calculated machining times with increasing precision.

Real-time information



A professional wants to know everything – the display shows him all relevant information and enables him to intervene in the live process. This way he has everything under control – and knows that he will always achieve the best results.

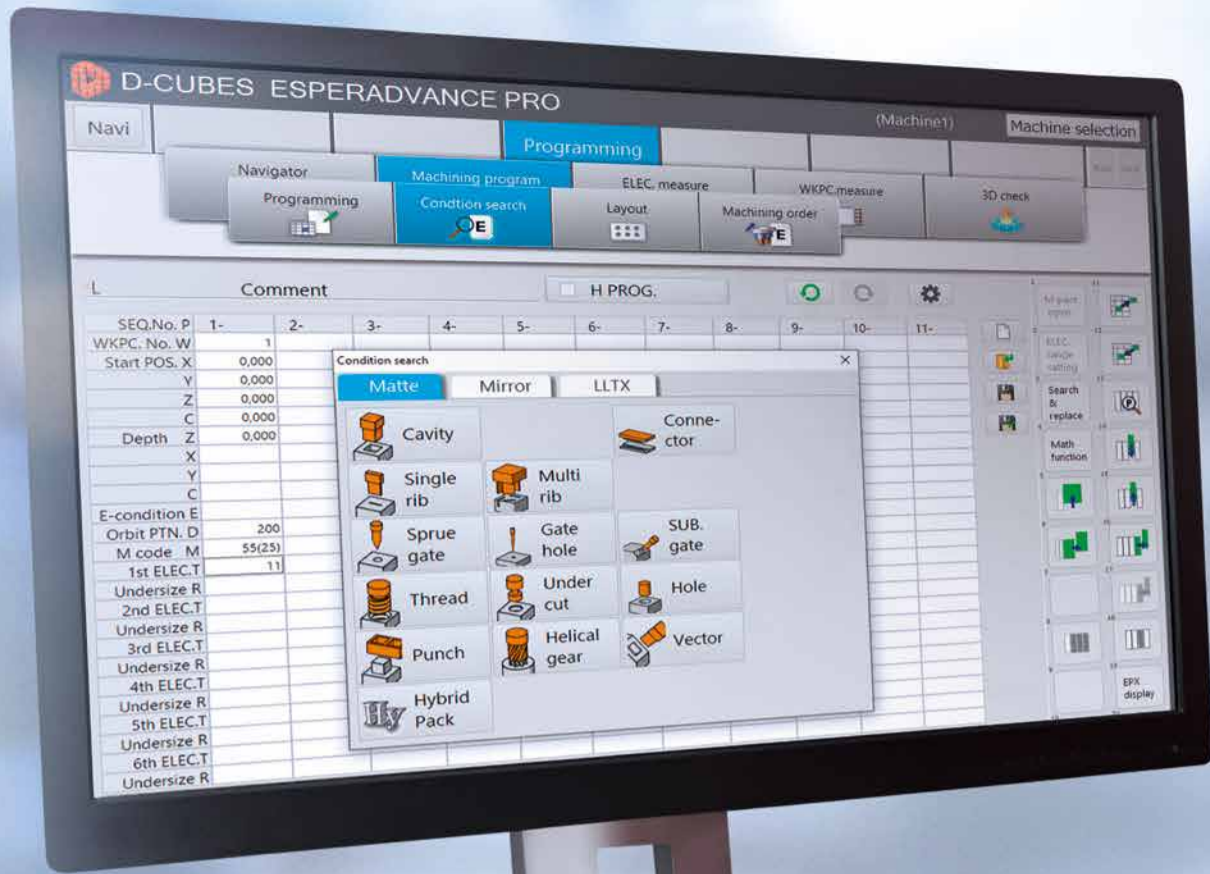

Everything under control at the PC or the machine



Programming: onboard/online/offline

A solution for every case in practice: same procedure at the control or PC



The user-friendly and straightforward ESPERADVANCE PRO programming tool can be found on the onboard control and is included in the standard range of equipment. The ESPERADVANCE PRO and ESPERADVANCE PRO lite include an online manual as a technical guide. The SG-R delivers excellent value for money across the board.

ESPERADVANCE PRO lite* – offline programming inclusive



Sometimes programming at the machine itself is the fastest and most efficient way to achieve your goal. More often, however, external programming at the PC is the more convenient and effective choice. Ergonomically optimised, without distraction and with all the convenience of programming while the machines do their job.

3D check – additional checking function at the machine



Optional



Boost the reliability of programming at the machine by checking the created program with simulations using Parasolid models. Programming has never been so simple – and reliable.

ESPERADVANCE PRO 3D* – for maximum convenience



Optional



The programming software with the maximum scale of functions. Programming based on 3D Parasolid, ESPERADVANCE PRO technology programming such as at the machine, 3D graphic simulation for maximum reliability – all inclusive. This option is the right choice for each and every automated die sinking system.

* Hardware requirements: Windows 7/10, CPU min. 2.0 GHz, min. 2 GB RAM, min. 2 GB free hard disk space, 2 USB ports



Simple operation via touch screen – just like on a smartphone

Sophisticated technology, simple programming. That's die sinking today



Machining strategy produced the easy way

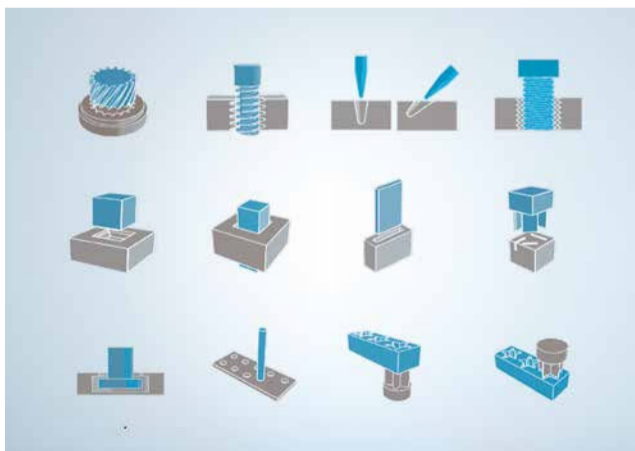

Ready for anything thanks to the extensive library in the control. Only the details of the respective task are still required, and from this the control automatically generates a complete machining program. By selecting the material pair electrode/workpiece, the technology is generated independently. Achieve results faster – for higher output and profits.

Dialogue-guided programming

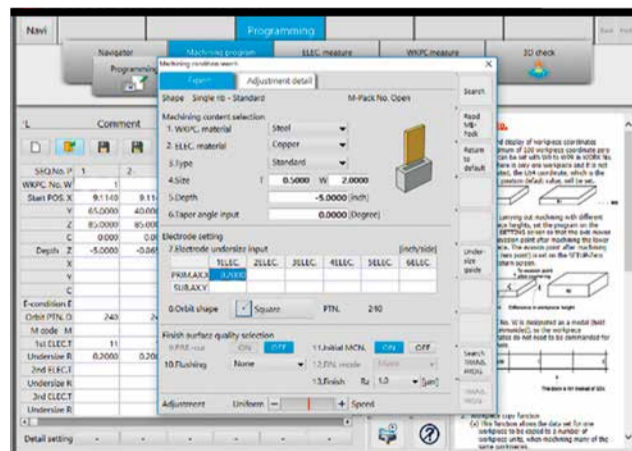

Machining programs are created entirely by means of dialogue guidance – at Mitsubishi Electric this is called ESPERADVANCE Navigator. Plain language selection windows guide the operator from set-up and technology selection to program start. Every user, from beginner to professional, will appreciate this.

Varied selection of orbits

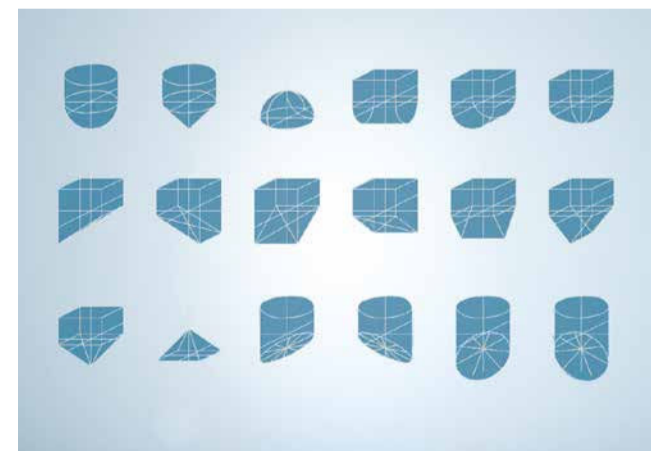

For a variety of applications, optimised deflection cycles are available that can be assigned on request. You need a cycle deviating from the norm? No problem – cycles can be easily put together with an editor. This is how intelligent operator support works.

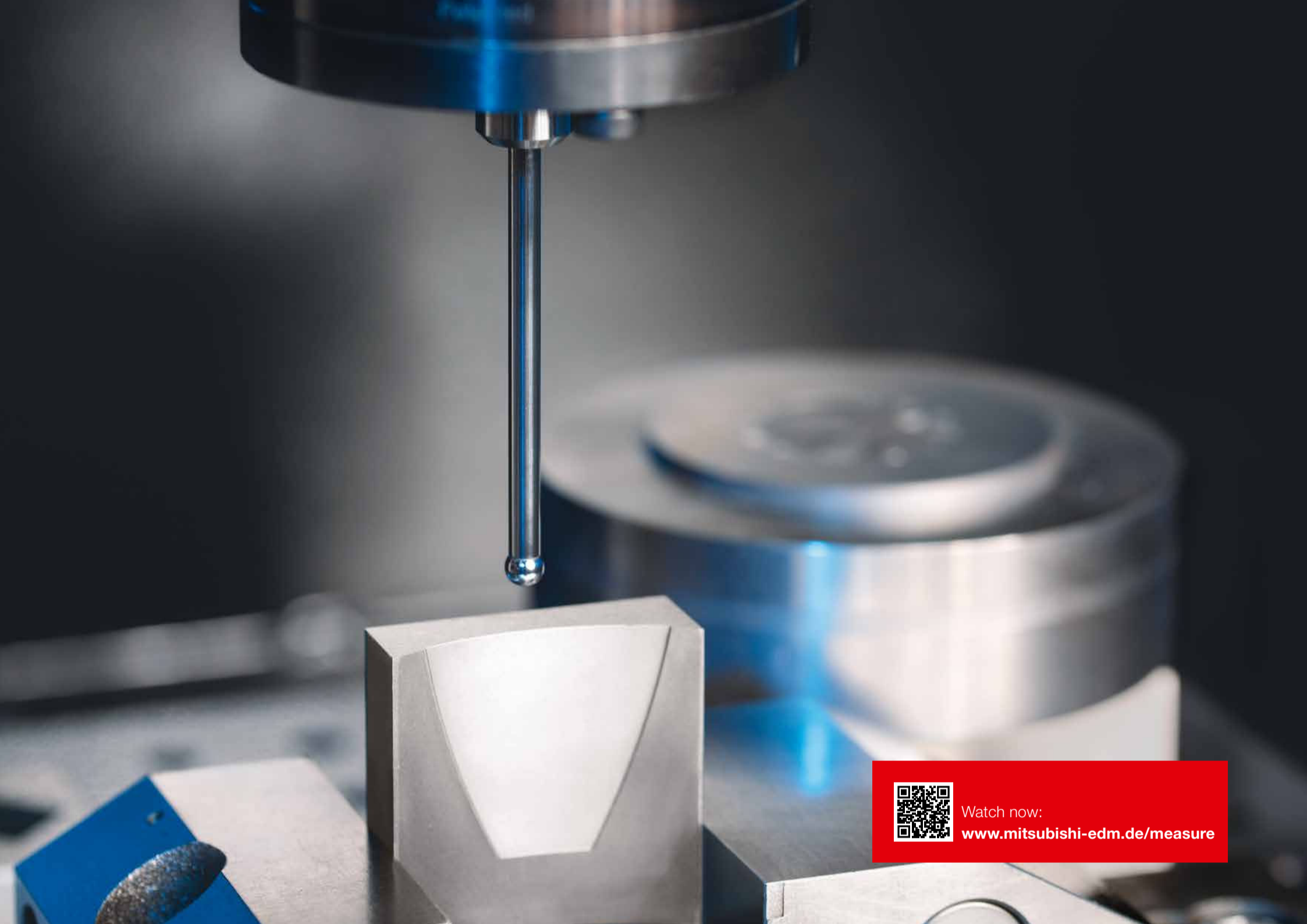



Watch now:
www.mitsubishi-edm.de/measure

Clamp and press *Start*

Set-up made easy

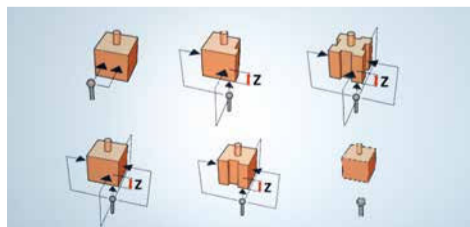

Probing the electrodes



The automatic and simple position detection of the electrodes allows you to work precisely, comfortably and quickly.

Probing the workpieces

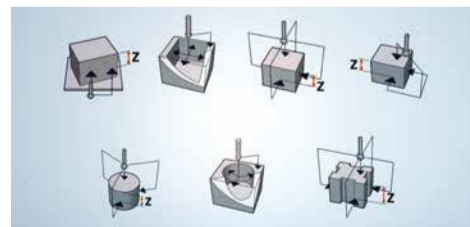
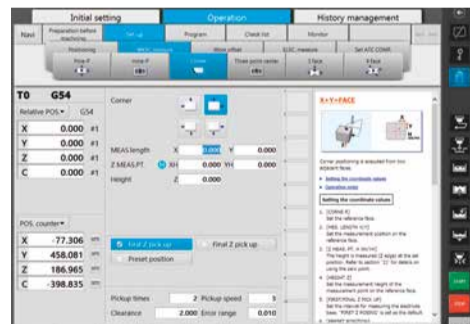

You can also detect the position of the workpieces with the same convenience as with the electrodes.

... or external measuring



External presetting on a measuring machine is of course also supported by the Mitsubishi Electric SG-R – for automated operation and maximised profitability!



**Remote control
with mcAnywhere**

Always up-to-date

The control you take with you



Control machines and keep an eye on processes – wherever you are. Relax while you work thanks to more intelligent communication. Ideal in combination with automation solutions and high process autonomy.

mcAnywhere Service

Rapid assistance from the Mitsubishi Electric experts.

mcAnywhere Control + Optional

The convenient and reliable remote control for your EDM system – powered by TeamViewer (TeamViewer license fees payable by the customer)

mcAnywhere Contact+

Any time, any place ... you're always up to date with direct status reports by email (external service program – capable of handling several machines).



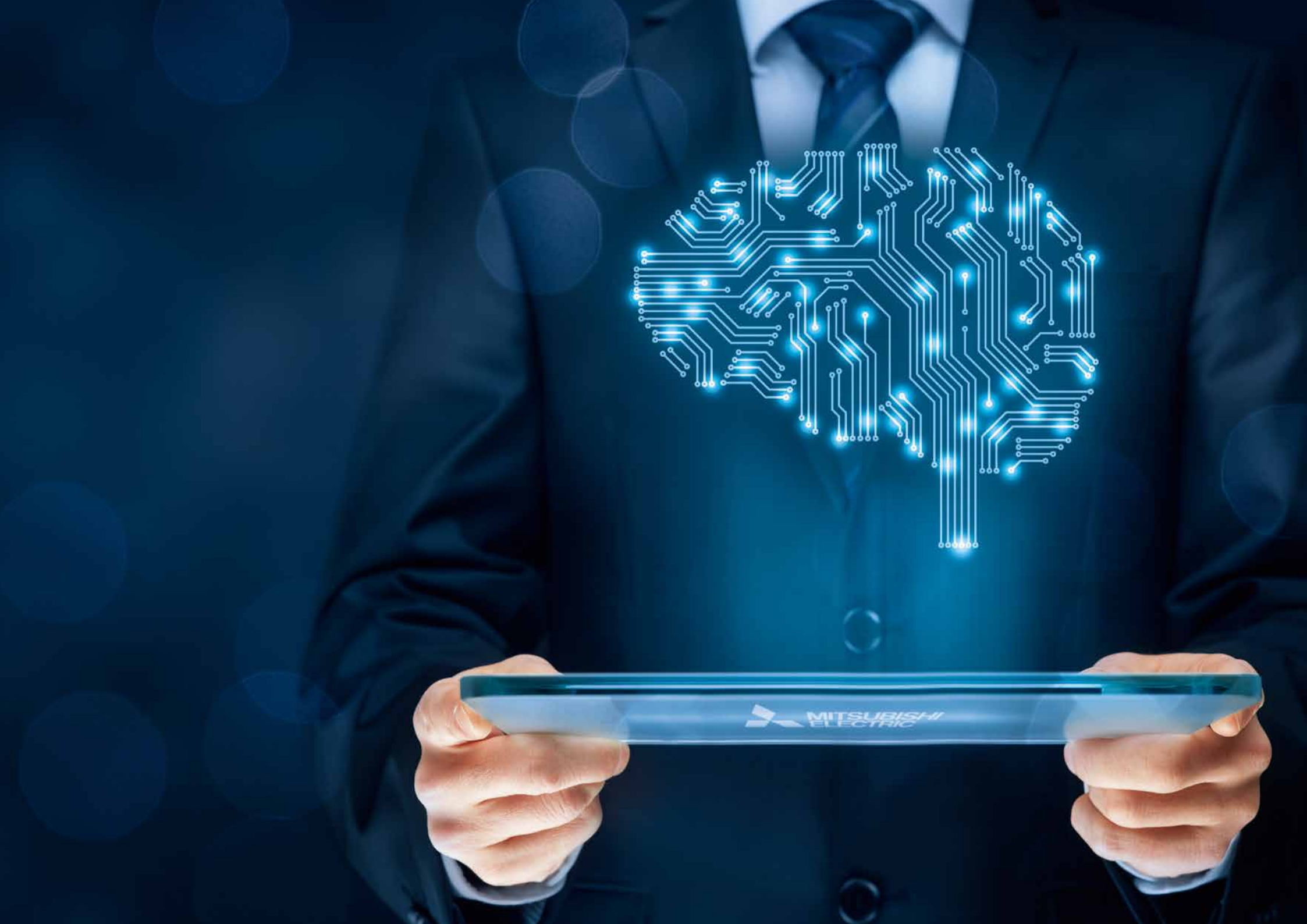

The intelligent control technology

Convenient, transparent and reliable – at all times

Connected into the future



The advanced D-CUBES M800 control supports the operator in every situation. It handles routine tasks and takes the effort out of programming. To ensure this, all SG-R machines are equipped with a wide range of networking options: Ethernet interface, USB interface, automation interface – full equipment included here as well.

Process data management



Operating and process data can be retrieved at the control. Available as standard is an export function for all process data, operating states, consumption data and maintenance states as well as alarms. This way the data from several machines can be viewed and evaluated in consolidated form, through to their integration in higher-order production management systems.

MTConnect interface



MTConnect is the offline and license-free communication standard of the machine-tool industry. This standard is supported by many leading software applications for ERP, production management and production monitoring. The SG-R includes the interface on the machine side in the standard equipment supplied.

Safety first



Anti-virus protection is ensured as standard by one of the world's leading software systems in security control.

MTConnect[®]

intel Security



C axis inclusive

The freely programmable precision C-axis, suitable for use in simultaneous operation, is included in the standard equipment supplied. All commonly used chucks are available.

The equipment giant is a maintenance dwarf

Safety as a matter of course



Safety always comes first and must therefore already be included in the basic equipment so that you can erode without supervision. The automatic extinguishing system is always included.

Linear scales + temperature compensation

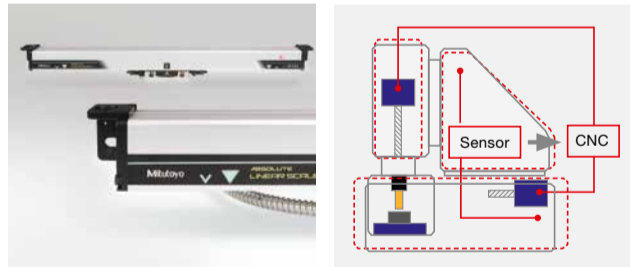

The machines of the SG-R series are equipped as standard with linear glass scales in all axes and active temperature compensation – for performance and precision.

Automatic central lubrication



Ensures frictionless processes long-term – without downtime, grease nipples or cumbersome grease guns. You can use this time more productively.

Rapid filter change



... during the live process – without tools or wasted time. Two hands, 32 seconds – and the filter is replaced.

Readily accessible electrode changer

+ Option



Access to the electrode changer from the front permits ergonomic loading.

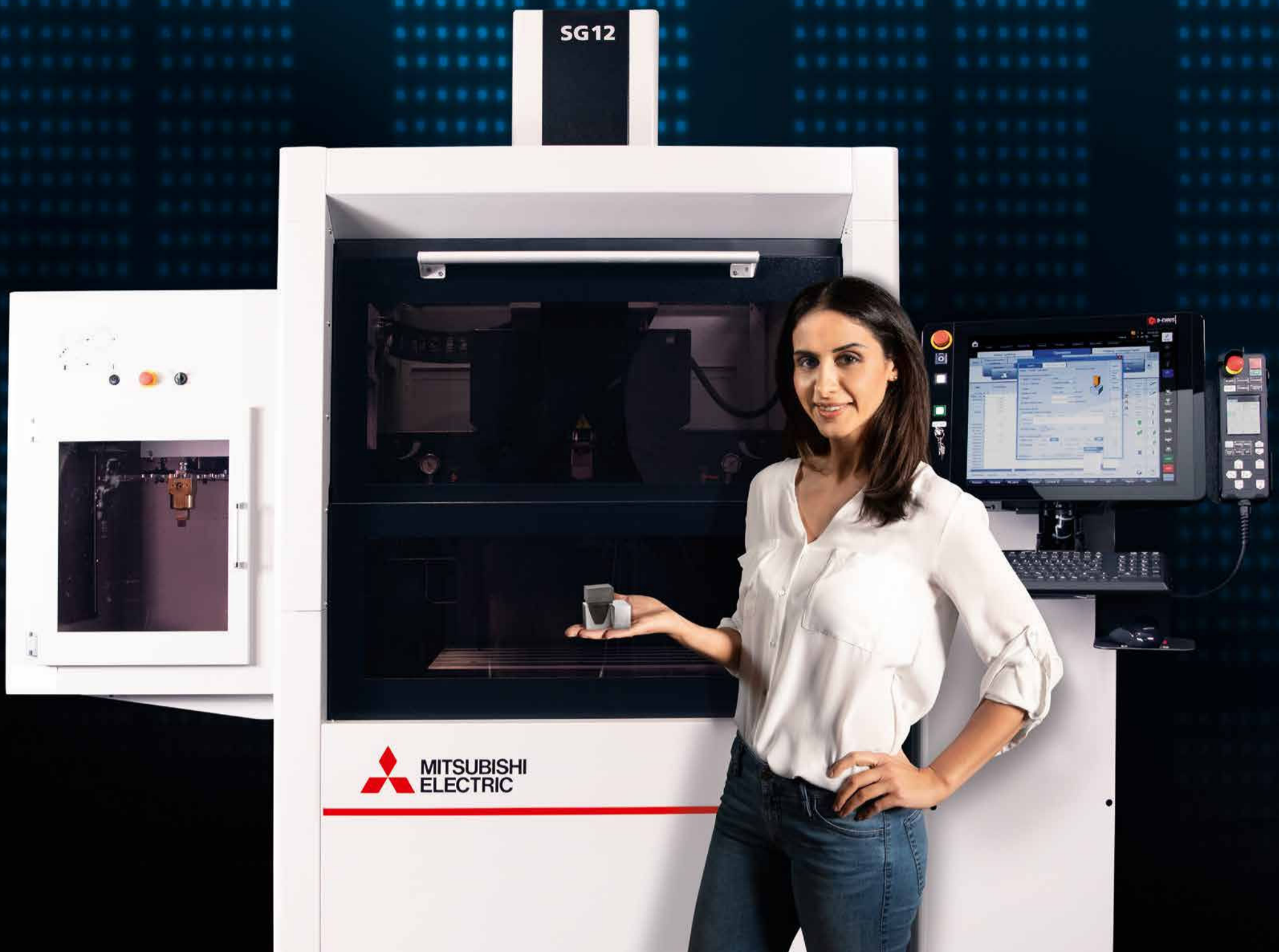

+ Optional

Adaptation to your requirements

Targeted and customised

High-speed spindle



Rotation with up to 1500 rpm, as a CNC axis in simultaneous use or for positioning the electrode – this makes everything possible. Resistant to high pressure and always CNC-integrated.

20-fold electrode changer



Ideally equipped for all eventualities – maximum versatility and impressive flexibility.

GV120 generator

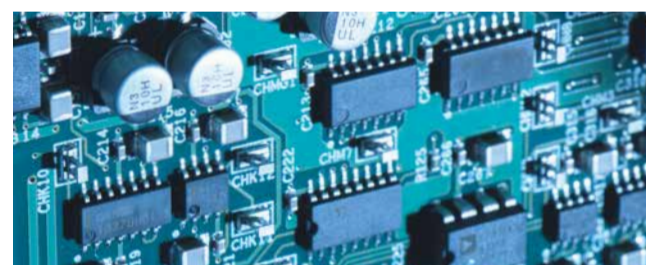

On the SG12R, the standard generator can be replaced by the more powerful 120 A generator of the type GV120 – if you need a high removal rate for large cavities.

Optional clamping systems (Hirschmann/System 3R)



Compatible with EROVA, System 3R and Hirschmann. The standard C axis interface is totally flexible.

HPS generator extension for machining PCD/CBN

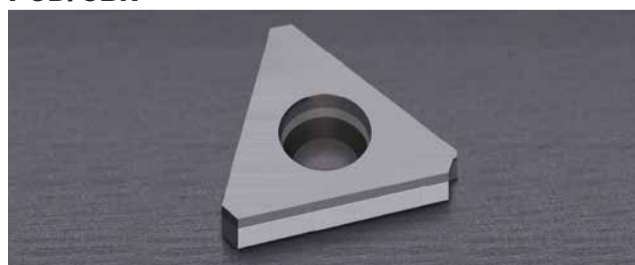

Even the machining of PCD and CBN materials is possible with "PCD Expansion".

3D check function

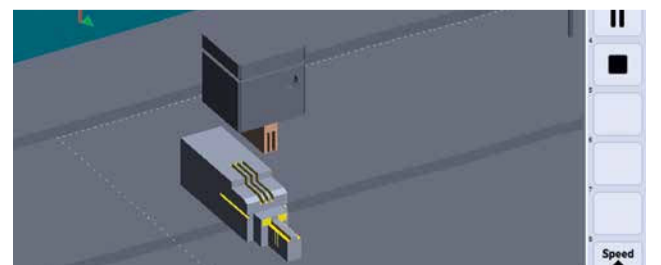

Extension of the programming functionality on the machine control to include checking of the created erosion program using imported 3D data (Parasolid).

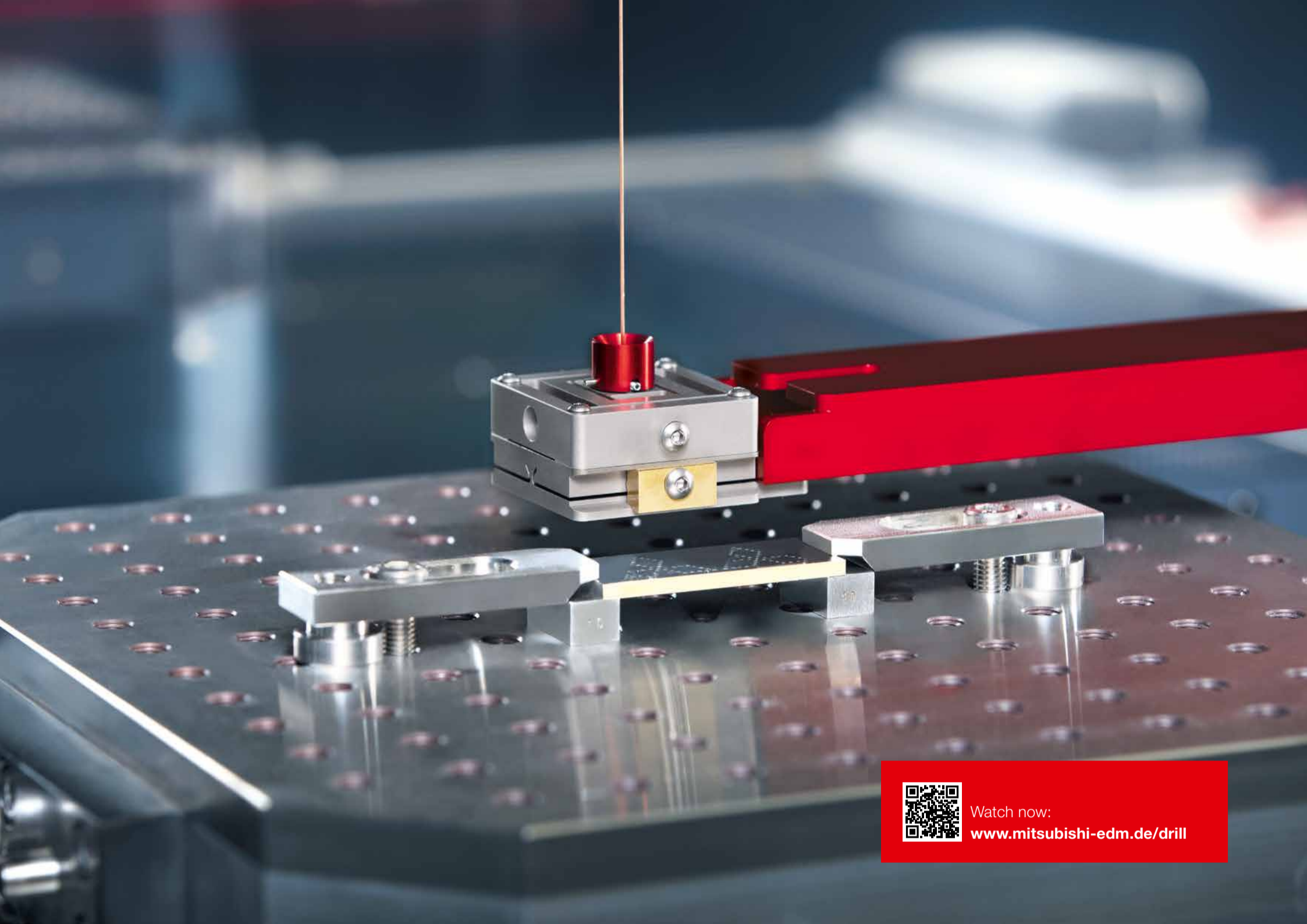

Watch now:
www.mitsubishi-edm.de/drill

 Optional

Custom extension

Intelligent solutions

ITS-HV-100 B axis

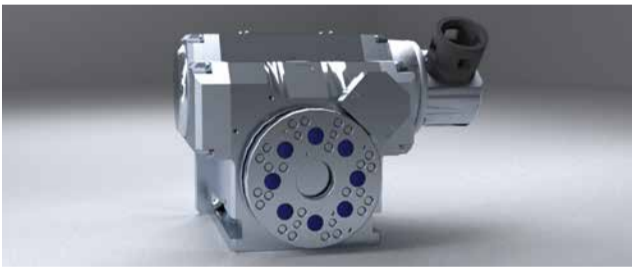

In addition to the four standard axes, a further simultaneous axis can be integrated as a B axis.

ITS-MS-24 rotary spindle

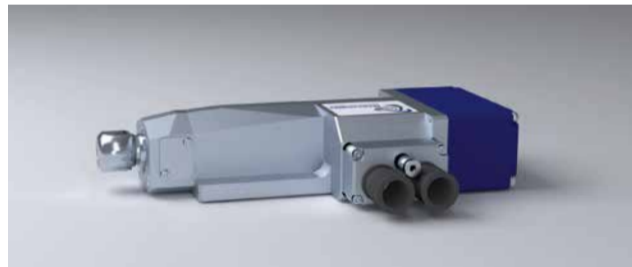

The rotating spindle can be integrated into the machine control system – so it can also act as a positioning axis and operate in simultaneous mode.

Status lamp



The three-stage status lamp in LED technology visibly shows the machine's state even at distance and looks good, too.

ERGO-LUX

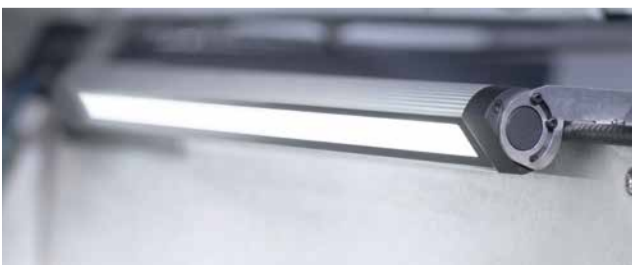

Additional ergonomic workspace lighting – so everything is brightly visible.

Fine hole drilling jig

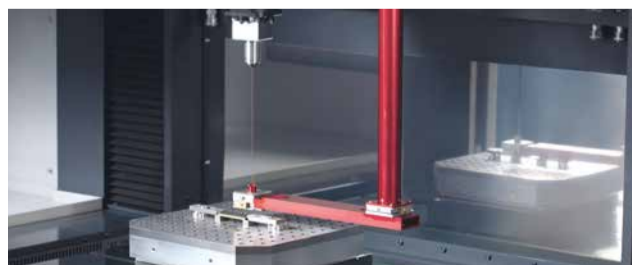

The fine hole drilling option enables the production of precise microscopic holes on the sinker EDM machine. We recommend its use in combination with the high-speed spindle and a high-pressure dielectric pump.

Exhaust air filters



Exhaust air filtration with return to the room. The electrostatic filter with a downstream activated carbon filter removes oil mist and vapours from the extracted exhaust air. Stationary installation or as a mobile unit for flexible use – tailored to individual requirements.



Automation depends on the field of use and range of applications – everything is possible!

Ready for automation

Flexibly into the future

Optimal solutions – custom-made, configurable or standardised

The handling systems and robots of various manufacturers can be seamlessly integrated. Mitsubishi Electric's EDM machines, known for their reliability and productivity, are "automation-ready". We would be pleased to show you configurations that have proven themselves in practice and help you to reduce costs and boost production capacity. All SG-R models come ex works with practical job planning, permitting live adaptation to requirements.



Handling devices from different manufacturers – welcome and easy to integrate.



One-to-one, also directly controlled by the machine.



Whether one, two or even several machines – automation with job management and component recognition by chip ID – convenient and scalable.



Flexible solution: Articulated-arm robot up to 75 kg of Mitsubishi Electric quality.



Service hotline: +49 (0) 2102 486 7600
Application support: +49 (0) 2102 486 7700
Monday to Friday: 7.30 am to 8 pm / Saturday: 9 am to 4 pm

Personal and competent

We are there for you – via hotline and also online

You don't like call centres and queuing systems? We don't either. With every Mitsubishi Electric EDM system you buy excellent service as part of the package. Service is performed by our own highly skilled service technicians so that production is kept dependably up and running. Users are assisted over the phone and benefit from the expertise and wealth of experience of Mitsubishi Electric specialists.

Warehousing and logistics



We supply all in-stock products (wear and spare parts) even outside normal business hours, e.g. by courier or collection. Our proximity to Düsseldorf Airport and motorway links enables us to ship parts at high speed.

Original Mitsubishi Electric parts



All standard spare parts of the Mitsubishi Electric consumables line are original imports or fabricated in Germany in accordance with the development and design specification. You receive original parts of immaculate quality at attractive prices.

Customer support online



Rapid online help to reduce downtime and expenditure on customer service calls. Application support with direct access to the machine control can provide the machine operator with optimal and rapid assistance for difficult tasks – everything to keep production running smoothly.



Trainings

Our specialists are there for you

Training



Users learn skilled operation right at the machine and at specially configured CNC workstations. This way you benefit most from a direct transfer of expertise. Training is available at the facilities of Mitsubishi Electric in Ratingen, Germany. Additionally, training courses are provided by our international partners.

Training centre



Training on our wire-cut and die-sinking systems takes place at our own technology and training centre in Ratingen.

Courses, seminars and user workshops

The varied programme covers everything from basic knowledge through to customised training geared precisely to your employees' learning needs. In addition, we also hold regular applications workshops – free of charge to our customers – which always deal with current topics in theory and practice.

Equipment and instructors

Our skilled instructors introduce you to our EDM systems in theory and practice. The training facilities are appointed with the latest technology, CNC simulators and peripheral equipment.

Certificates

All training participants receive a certificate on completing a course.

SG8R

Highest precision and filigree details with finest surfaces

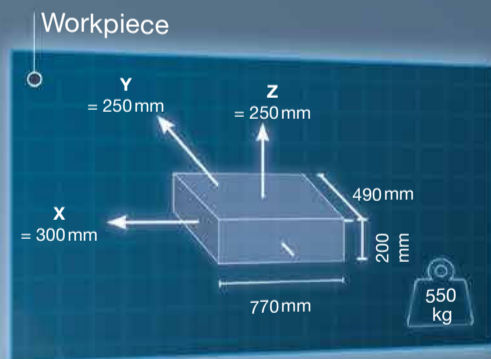

Machine weight 2000 kg
 Generator weight 260 kg
 Machine height 2140 mm

Required minimum dimensions for door/gate passageways (w x h) in mm 1100 x 2150
 With LS-10T 1495 x 2150
 With LS-20T 1720 x 2150

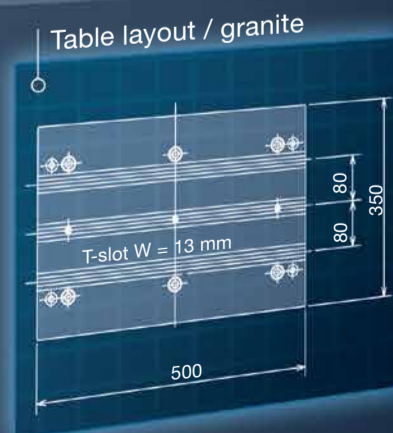
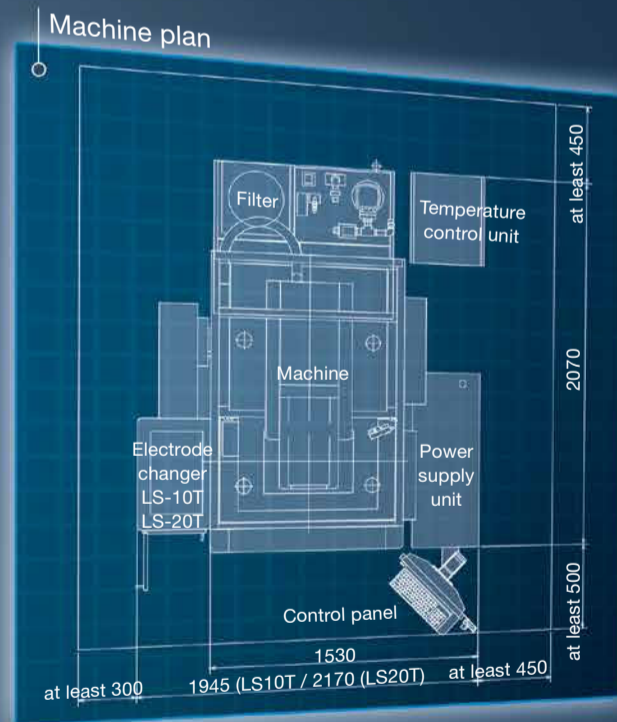

SG12R

Fully equipped precision machine,
ideal and prepared for automation

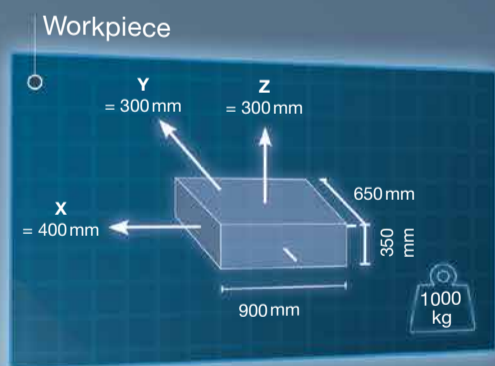

Machine weight 3500 kg
 Generator weight 260 kg (at 120 A: 300kg)
 Machine height 2420 mm

Machine plan

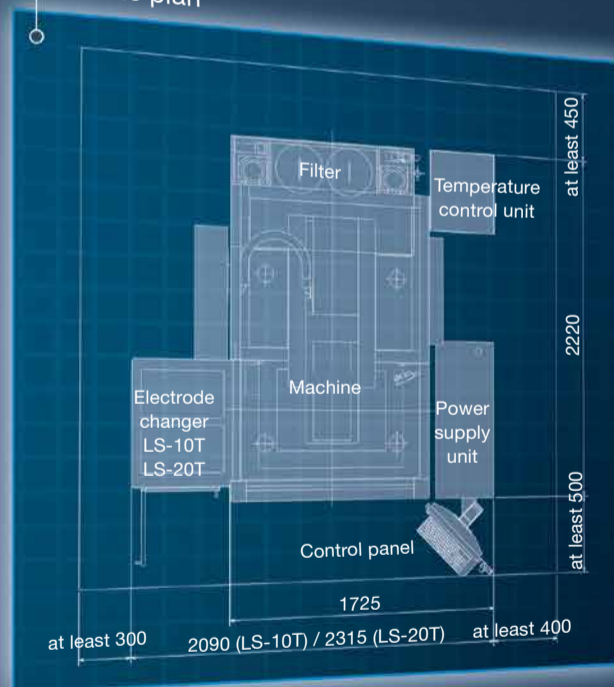

Required minimum dimensions for
 door/gate passageways (w x h) in mm 1300 x 2430
 With LS-10T 1680 x 2430
 With LS-20T 1910 x 2430

Table layout / steel

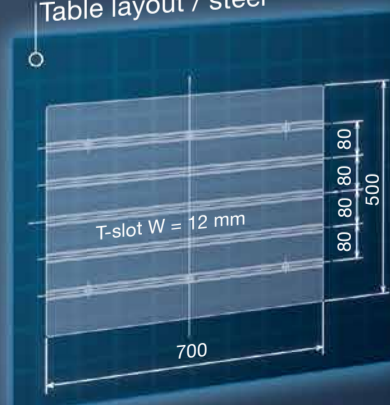

Crane loading? Of course!



SG28R

Size meets precision with full features – SG28R combines this perfectly.

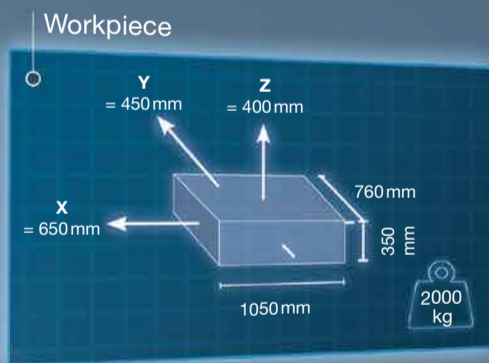

Machine weight 5600 kg
 Generator weight 260 kg (at 120 A: 300kg)
 Machine height 2745 mm

Required minimum dimensions for door/gate passageways (w x h) in mm 1990 x 2745
 With LS-20T. 2395 x 2745

Machine plan

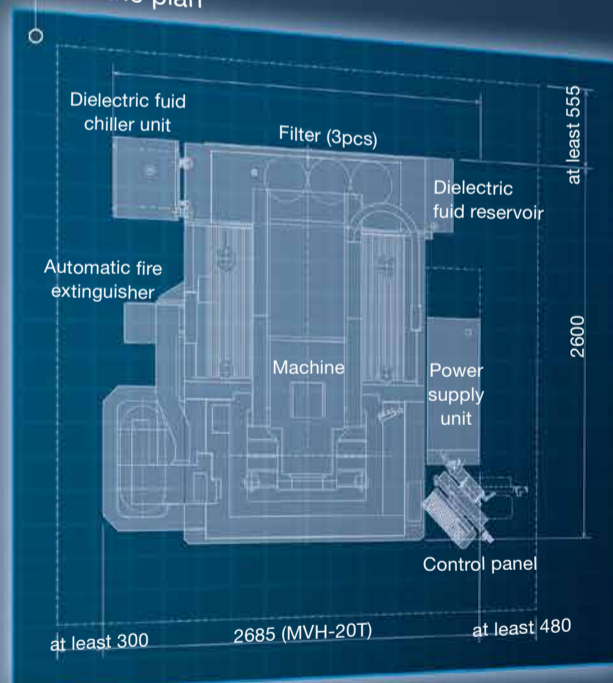
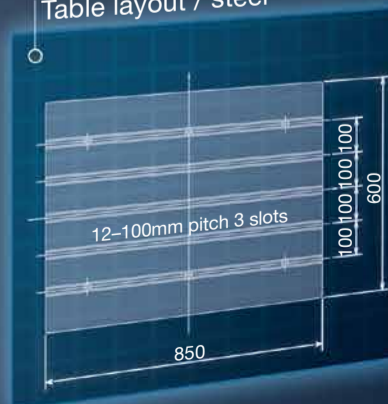
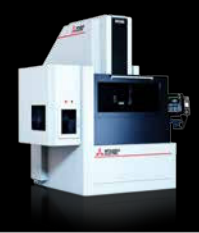

Table layout / steel





Machine	SG8R	SG12R	SG28R
Travel (X/Y/Z) in mm	300/250/250	400/300/300	650/450/400
Max. workpiece dimensions (W x D x H) in mm	770x490x200	900x650x350	1050 x 760 x 350
Max. workpiece weight in kg	550	1000	2000
Max. electrode weight in kg	25	50	200
Table dimensions (WxD) in mm	500x350	700x500	850 x 600
Table layout	Granite / 3 T-slots	Steel / 5 T-slots	Steel / 5 slots
Daylight (table – C-axis with EROWA chuck) in mm	150–400	200–500	175–575
Max. dielectric filling level (measured from worktable surface)	250	400	400
Overall dimensions with tool changer (W x D x H) in mm	1530 [2140] x 2070 x 2140	1725 [2285] x 2200 x 2420	2620 x 2600 x 2745
Machine weight in kg	2000	3500	5800
Mains voltage	3-phase 400 V/AC, 50/60 Hz		
Tank unit / filter system			
Tank capacity in l	260	360	595
Filter particle size in µm/filter elements	3/1	3/2	3/3
Temperature control	Dielectric cooling unit		
Weight (dry) in kg	Included in machine weight		
Generator			
Power supply unit	Regenerative transistor pulse type		
Cooling method	Fully sealed/indirect air cooling		
Max. output current in A	80	80 (optional 120)	
Dimensions (WxDxH) in mm (included in overall dimensions)	410 x 1000 x 1540	410 x 1000 x 1540 (at 120A: 410 x 1240 x 1600)	
Weight in kg (included in machine weight)	326	326 (at 120A: 482)	
Control			
Input method	Keyboard, USB flash drive, Ethernet, 19" touchscreen		
Control system	CNC, closed circuit		
Min. command step X/Y/Z in µm/C in °	0.1/0.1		
Min. axis resolution in µm	0.1		

Equipment	SG8R	SG12R	SG28R
Work table steel	–	Yes	Yes
Work table granite	Yes	–	–
10-fold electrode changer	Factory option		
20-fold electrode changer	Factory option		
High-Speed Spindle	Factory option		
Clamping system EROWA	Yes		
Clamping system 3R / Hirschmann	Optional		
Generator GV120 (120 A)	–	Factory option	
HPS circuit for PCD/CBN	Optional		
Fine hole drilling jig	Optional		
High-pressure pump > 50 bar	Optional		
Tricolour status lamp	Optional		
ERGO-LUX	Optional		
3D check	Optional		
Ethernet TCP/IP	Yes		
DNC/FTP	Yes		
Operating data output	Yes		
MT-Connect	Yes		
mcAnywhere Service	Yes		
mcAnywhere Contact+	Yes		
mcAnywhere Control	Optional		
Automation kit incl. safety interface	Optional		
Offline Programming E.S.P.E.R. Advance Pro Lite	Yes		
Offline Programming E.S.P.E.R. Advance Pro	Optional		

Power connection: 3-phase 400V/AC, PE, ± 10%, 50/60Hz, primary fuse 32A slow

Pneumatic connection: 5–7kg/cm², 500–700kpa, minimum air flow rate 75l/min, 3/8" hose connection

The EDM system should be set up on a suitable hard industrial floor and preferably on a consolidated concrete floor. Any shielding that may be necessary in conformity with the EMC Directive is not included in the equipment supplied by Mitsubishi Electric.

The cooling unit contains fluorinated greenhouse gas R407C. For further information, please refer to the associated operating instructions.



Details can be found in the assembly plan of the machine:
www.mitsubishi-edm.de/download

Partners

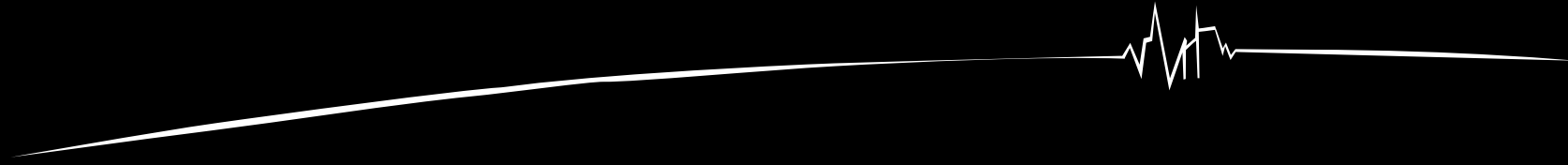

EN Subject to technical change and error / 08.09.2022 / Art. No. 504778
Details of image rights, trademark rights and other legal notices at www.mitsubishi-edm.de/notices

MITSUBISHI ELECTRIC EUROPE B.V.

Mechatronics Machinery / Mitsubishi-Electric-Platz 1 / 40882 Ratingen / Germany / Tel. +49 (0) 2102 486-6120 / Fax +49 (0) 2102 486-7090
edm.sales@mee.com / www.mitsubishi-edm.de

